



# BEVERLEY BLARNEY

Edition 440

June 2021

No Charge



NEIGHBOURHOOD CENTRE WEEK 2021

## GOOD THYMES IN THE GARDEN

To celebrate Neighbourhood Centre Week, the Beverley CRC in collaboration with our Community Garden Sub Committee hosted multiple gardening based activities throughout the week to help our community to combat loneliness by hosting a range of hands on and interactive based workshops.



We had many new faces join in the activities and the Community Garden volunteers were so excited to see new people at the garden. The volunteers were able to proudly showcase how far the garden has developed through volunteering and partnerships within the community. Read more on page 17.

PROUDLY  
SUPPORTED BY





## SHIRE OF BEVERLEY PRESIDENT'S REPORT



### ANZ Bank – Beverley Branch Closure

Thank you to all the residents who completed the ANZ Bank Closure survey form and lodged complaints directly to the ANZ. The ANZ have responded with the assurance of a smart ATM (location still to be determined). The information from the surveys will still be collated for a report to be sent to ANZ. Thank you to Dee Ridgway for undertaking this action on behalf of the community.

### 2019/20 Annual Report and Annual Electors Meeting

The 2019/20 Annual Report is available from the Shire Office and website. The Annual Electors Meeting will be held **Monday 14 June 2021, 6pm at the Cornerstone Building. RSVP's are encouraged for social distancing and catering requirements** (Shire admin office 9646 1200 or [admin@beverley.wa.gov.au](mailto:admin@beverley.wa.gov.au)).

### Avondale Machinery Farm

Council are seeking public comment from the community of the future of the Avondale Farm Machinery Museum. A report and comment form is available from the Shire Office or the Shire website. Public comment will guide Council on whether to keep the Museum, move it or walk away from it. Please respond by 30 June, [admin@beverley.wa.gov.au](mailto:admin@beverley.wa.gov.au) or in person at the comment box at the Shire Office.

### Local Government Elections – October 2021

If you are interested in becoming a Councillor and running in the local elections in October 2021 please do not hesitate to have a chat with a current Councillor. Later in the year the Shire will hold information sessions that will cover training requirements, meeting expectations and legislative requirements. The Shire will also have a tent at the Beverley Show.

### Roads

Work has started on the shoulder reconstruction on Morbinning Road between East Lynne Road and Caroling Bally Bally Road. This is in preparation for the widening and sealing of this section next year.

The Shire has 34 bridges which have had their annual inspection, 26 timber and 8 large culverts (box culvert crossings are not classified as bridges). The Kokeby East bridge has had remedial props placed under it and will be further reduced in width until the bridge is eventually replaced. Please slow down and use caution when crossing.

### Caravan Park Cabins

The construction of the Beverley Caravan Park cabins is now complete. The internal furnishings are being installed and the road and landscaping is underway. Council are hopeful they will be available for bookings mid-July.

### Vincent Street Streetscape Project

There has been a lot of work behind the scenes trying to bring this project to fruition. One of the side-effects COVID stimulus funding and projects has been a natural increase of construction costs as companies are no longer fighting for work. Unfortunately, this has severely hampered our progress. Designs and plans have been reworked to meet our budget. Council are reviewing recent tenders and hope to move forward with the project, but most likely on a smaller scale than originally anticipated.

### Spring Back to Beverley 2022

In case you are unaware, a working group of community members along with Shire staff are preparing to celebrate the 150 year anniversaries of the Beverley Road Board and the Dead Finish Museum (the oldest building in Beverley). The weekend event, 24 – 25 September 2022 is called "Spring Back to Beverley" and is now an event on Facebook. If you click 'interested' or 'going' you will be updated as information comes to hand.

### Beverley to Perth Exhibit – Visitor Centre Cornerstone

A new cycling exhibit is on show at the Visitor Centre. Thanks to the WA Historical Cycle Club and Toby Hodgson (Beverley Heroic) for curating the exhibit.

### Thanks

On a personal note, many thanks to Linda, Jenny, Eva and Kim for their care and assistance during my recent visit and tour of our local and regional health services!!

**Cr Don Davis**  
**Shire President**

Sad Day for Beverley WA  
Wednesday 29 September 2021  
ANZ Beverley Branch due to close

The announced closure of Beverley ANZ is a distressing prospect for residents, local and regional businesses, community organisations and visitors. The long term effect on our vibrant & growing rural community as a result of our only bank closing is a significant concern.

A feedback questionnaire sent to all PO, RMB and town letter boxes in our community closed on 28/5/2021 and the many responses will now be collated.

Respond to the signatory of your letter or email which advised about the bank closure and explain how you will be affected. If you don't use email then the postal address is as follows:-

Attn: whoever signed your letter  
ANZ, Level 5, 240 St Georges Terrace, Perth WA 6000

Updated information was received in the last week of May, that the SMART ATM is to be retaining with a location yet to be determined. This is terrific news!

Dee Ridgway M: 0428 464 007 E: deeridgway@bigpond.com



## Shire of Beverley

### 2021 Council Meetings

Meetings commence at 3pm

Tuesday 22 June 2021

Tuesday 27 July 2021

Tuesday 24 August 2021

Tuesday 28 September 2021

Tuesday 26 October 2021

Tuesday 23 November 2021

Tuesday 14 December 2021



**AVON TERRACE DENTAL | YORK**  
your smile. our passion.

Now Open 9am to 5pm Monday to Friday!

#### Our Services:

- Preventative and General Dentistry
- Children's Dentistry
- Anxiety Management
- Cosmetic Dentistry
- Implants
- Endodontics
- Crown and Bridge
- Teeth Whitening
- New Dentures and Repairs
- Emergency Dental Care
- Veterans' Affairs

*New  
Patients  
Welcome!*

Participating provider for

129 Avon Terrace  
York WA 6302  
(08) 9641 2123



## Come visit the Beverley Mens Shed

New members always welcome.

**Open Tuesday morning's  
8:30am - 11:30am  
at the Old Fire Station.**

Drop in for a coffee and a chat and have a look at all of the great equipment available for member use.

#### **Did you know?**

Mens Shed Members can use the tools and facilities for their own projects at anytime.

For more information,  
please contact  
our President  
Jon Rothwell  
Phone 0447 872 128  
or email  
president@beverleymenshed.com

Community Bank · York & Districts

# A better banking experience.

## Right on your doorstep

We deliver the products and technology you'd expect from a big bank, plus the personal service you wouldn't.

Feel good about who you bank with. Try Bendigo.

**Find out more. Call 9641 2609 or search Bendigo Bank York.**

Home loans

Accounts

Credit cards

Personal loans

Business

Insurance

Financial planning

Travel and International

Investing and Super

Agribusiness



**BANK LOCAL**

 **Bendigo Bank**

\*All lending products are subject to the Bank's normal lending criteria. Terms, conditions, fees and charges apply and may be varied at any time. Bendigo and Adelaide Bank Limited ABN 11 068 049 178, AFSL/Australian Credit Licence 237879. A1455028 OUT\_2061738 11/05/2021

# Free Shed

Situated at Beverley Airfield  
Dimensions: 20m (Single span) x10m x 4m High.

This shed has been used as a hanger for many years. It has heavy duty corrugated tin nailed to jarrah beams, steel trusses, railway iron pylons with a single 20 metres span opening.

If you are interested, please contact me.  
Geoff Overheu. Tel: 0407 575 216



## BEVERLEY BADMINTON

**Our season is up and running  
and it's great to see the members back.**

**We would love to have more players,  
so come on down to the hall on  
Wednesday's mornings at 9am.**

**We have great members and lots of laughter.  
If you just fancy having a go, beginner or  
experienced, you would be most welcome.  
Racquets are provided,  
please wear enclosed shoes.**

**Follow our Facebook page for updates.  
For further information contact  
Elaine on 0408 905 478 or  
email: [beverleybaddy@outlook.com](mailto:beverleybaddy@outlook.com)**

### **Shed Sale**

**11<sup>th</sup> – 13<sup>th</sup> June**

**Lot 95 Craig Road Jelcobine**

Building materials  
Water pump and fittings  
Timber flooring (floating)  
Tools, hand winch, cumalong  
Air conditioners (window)  
Beds, single and double  
Side board, corner unit, lounge  
Kitchen table/chairs  
Camping gear  
4WD Recovery gear  
Camper Trailer

2 x 4 bed, 2 bath single man's donga's with  
instantaneous gas HWS, 240 Volt wiring.

**Call Eric on 0447 190 128**



# COMMUNITY GRANTS



Does your incorporated organisation have a local project that needs some extra financial help?

Application packages will be available from the Shire office from 1st July 2021 and submissions close 31st July 2021. Late applications will not be accepted.

Please contact the Shire Office to discuss the eligibility of your project/application before applying.

Further information about eligibility and application criteria is available in the application package.

Enquiries  
Executive Assistant or Project Officer  
T: (08) 9646 1200  
E: [execassist@beverley.wa.gov.au](mailto:execassist@beverley.wa.gov.au)  
E: [projects@beverley.wa.gov.au](mailto:projects@beverley.wa.gov.au)

## MINOR COMMUNITY GRANTS

Funding up to a maximum of \$1,000 with no matching funds from applicant

Projects must seek to further the development of one of the following:

- early years (0 to 4 years) ;
- environment;
- history and or heritage;
- seniors;
- tourism;
- volunteer upskilling;
- youth (5 to 18 years) .

## MAJOR COMMUNITY GRANTS

Funding between \$1,001 & \$5,000  
50% of the total project cost in matching funds from applicant

## V8 Tractor Pulls Ride on Mower and Kids Kart Races

Photo courtesy of Vicki White



**Beverley Racecourse  
Hamersley St**

**10am-6pm  
Gates open at 10am,  
racing starts at 12 noon**

**Family \$30,  
Adults \$15,  
Children under 16 \$5**

**2021 Race Dates  
6 June, 10 July &  
26 September 2021**

FB @tractorpulling and lawn mower racing in WA  
Email tractorpullwa@gmail.com  
Phone 0403 506 830

### OFF SEASON SHEARER.....

Handy man, odd jobs, gutter  
clearing, yard clean-ups,  
window cleaning, lamb tailing.  
Call Abe 0482 797 504



## COUNTRY LINE DANCING

Thursday mornings at  
the Town Hall

Enquiries to  
Jan 0429 952 177



Government of Western Australia  
WA Country Health Service

## BEVERLEY HEALTH SERVICE

### Winter warmers stall

**Friday 25 June 2021**

**Lion's stall 10.00am – 2.00pm  
-Next to IGA-**

**This is your opportunity to purchase your beanies,  
scarves, knee rugs, and many other winter warmers.**

**Raffles**

**All proceeds to the Beverley Aged Care**

### Get in touch

WA Country Health Service

189 Wellington Street  
Perth, Western Australia 6000  
Telephone: 08 9223 8500  
Facsimile: 08 9223 8599

[www.wacountry.health.wa.gov.au](http://www.wacountry.health.wa.gov.au)

To provide feedback on this publication email  
vicki.conrad@heath.wa.gov.au. Alternative formats can  
be provided on request. © WA Country Health Service.



COMMUNITY | COMPASSION | QUALITY | INTEGRITY | EQUITY | CURIOSITY



BEVERLEY ELECTRICAL SERVICES

## BEVERLEY ELECTRICAL SERVICES

EC 006578

***Proudly servicing Beverley and surrounding  
districts since 2010, this locally owned  
family business can help you with all your  
Electrical needs***

**Karl and his team offer**

**All your General Electrical Requirements PLUS**

- Cel-Fi Mobile Boosters
- Quality LED Lighting Solutions for any application
- Split Air Con Installations
- Trenching for underground power
- Quality Solar Systems
- Telephone & Data Cabling

**Call Karl on  
9646 1222**

**4 De Lisle Street, Beverley  
[sales@beverleyelectrical.com.au](mailto:sales@beverleyelectrical.com.au)**



Stanley Alexander Dorman  
22/10/1941 - 15/05/2021

We would like to sincerely  
thank the Brookton and  
Beverley volunteers and  
Northam and Beverley Police  
for their service and support on  
Saturday 15 May.

From Carole Dorman  
and daughters

PIECE 4 IS ALL ABOUT...

# ENTERTAINMENT

Want to know some of the Entertainment at the show???



**Livestock Demos**

**Facepainter**

**Old MacDonald's Farm**

**Live Music**

**Live Demonstrations**

**Climbing Wall**

**Show Bags**

**Bouncy Castles**

**Little Louie Truck**

**Early Years Tent**

**Coastal Pipe Band**

**Lamb's Playpen Free Ride**

**FIREWORKS**

Beverley Agricultural Show  
Saturday, August 21st, 2021



## BEVERLEY HOSPITAL AUXILIARY INC

### NOTICE OF ANNUAL GENERAL MEETING

Monday 05 July at 2pm

Notice is hereby given of the Annual General Meeting of the Beverley Hospital Auxiliary Inc. The AGM will be held on 05 July at 2pm at the Hotel Beverley.

All positions: President, Vice President, Secretary, Treasurer, Auditor; will be declared open

Our scheduled committee meeting will follow the AGM.

Prior to the AGM, members are invited to have lunch together (at your expense) at the Hotel Beverley at 12 noon.

Glenys Lane - President  
0437 807 454

Jo Sims - Secretary/Treasurer  
0400 661 256

## ACTIVATED BAMBOO CHARCOAL AIR PURIFIER ECO PACKS

**NEW CLEAN GREEN SAFE**

### HOW DO THEY WORK?

AIR passes through the linen cover to the porous Bamboo Charcoal which **absorbs odours**, allergens and moisture. The natural filtering helps prevent mould, mildew and bacteria from forming.

### WHERE TO USE?

DEODORISE your home, from bathroom to kitchen to pet area. Refresh personal spaces in hospitals & retreats. Perfect for your car, caravan or boat.

### HOW LONG DO THEY LAST?

KINGPIN sustainable ECO PACKS have a lifespan of 2 years & are reactivated by placing them in direct sunlight for 1 hour a month. The UV light disperses the moisture and odours and attacks the protein of viruses.

20cm<sup>2</sup>

**SHOP ONLINE AT: [www.kingpinpegs.com.au](http://www.kingpinpegs.com.au)**



**KINGPIN** CONTACT US: 0417 913 869





## Beverley Historical Society Dead Finish Museum

bhsdeadfinish@gmail.com

Our last meeting held on the 10 May was very well attended, the most we have had in a long time.

In the morning we held a Busy Bee with sorting and wrapping the photos in acid free paper and placing in new files in our new fireproof filing cabinet. A big thank you to our wonderful volunteers.

By the time the Blarney has been printed we would have had members of the Northam Heritage Group visit on Sunday 23 for a look at our lovely Museum and morning tea.

On Monday 14 June we are going on a small field trip (destination yet to be decided). We will be leaving the Museum at 10.30am.

Next meeting will be Monday 14 June 2021 at 1.30pm.

New members are most welcome.



### BEVERLEY RSL SUB BRANCH General Meeting

**Date:** Monday 14 June 2021

**Time:** 5.00pm (1700hrs)

**Venue:** RSL Hall 50 Forrest St.

RSL members please note that in future that the RSL General Meeting will be held on the first Monday of each month starting at 5:00pm (1700hrs) at the RSL Hall 50 Forrest Street.

### BILL CHAMBERS

#### Chartered Accountant & Registered Tax Agent

Tax return preparation

Financial and accounting  
advisory services

Office hours:  
First and third Wednesday  
9.30am - 5.00pm

129 Vincent Street, Beverley  
9646 1566 (Monday - Friday)



Government of **Western Australia**  
Department of **Planning, Lands and Heritage**

### PUBLIC NOTICE Land Use and Employment Survey

During May through to July 2021, the Department of Planning, Lands and Heritage is conducting a land use and employment survey of businesses in the Avon Arc Region and the Shire of Gingin. The Avon Arc includes the Shires of Beverley, Brookton, Chittering, Northam, Toodyay and York.

The survey is undertaken to assist with land use planning to help guide where people will live and work in the future.

Trained data collectors will canvas all commercial, industrial, public purpose and recreation/open space business entities in the nominated regions to collect generic information relating to land use and employment, including:

- type of business activity conducted
- how much floor space the business activity occupies
- how many people work in the business activity.

All data collectors will carry relevant identification and the responses gathered will be collated and not identifiable to individual businesses. If you have any queries about the survey or our data collectors, please email Rebecca Till at [lues@dplh.wa.gov.au](mailto:lues@dplh.wa.gov.au)

More information is available online at <https://dplh.wa.gov.au/lues>

### TV ANTENNAS UHF CB Sales, Service

Onsite installation & repairs.

Bench repairs.

TV reception problem solving  
& new systems.

Satellite TV systems supplied and  
installed.

Caravan and mobile home TV problem  
solving.

Mobile phone reception solutions  
for farm and vehicles.

**Regional Antennas  
Plus**

**Phone: Alan Primrose  
0408 002 965**



# SWAP IT UP



Come along for some fun and swap your renowned goodies for someone else's infamous, delicious wares.

Think outside the box, if you're not sure you can make something, maybe you could offer labour instead of goods.



Anyone has the right to respectfully decline your offer. Maybe ask them what you could swap next time to seal the deal.



Absolutely no money is to be exchanged during the event, sorry no exceptions.



Pro tip - plan ahead, think about what would I like to swap verses what would I need to bring to sweeten the deal?



Don't limit yourself to bringing one thing to swap, you may need bargaining power with multiple goods to get exactly what you're after.



**LAST MONDAY OF EVERY MONTH  
2.30PM - 3.30PM AT THE CRC  
ENTRY FREE | AFTERNOON TEA \$5**



## BEVERLEY CWA MOTHER'S DAY DEVONSHIRE MORNING TEA

On Saturday 08 May, the CWA held a Mother's Day Devonshire morning tea. With all that has happened recently, we were pleased to see many come to this event and we hope you all enjoyed yourselves as much as we did holding this event.

As well as the morning tea, we held a raffle with many fantastic prizes. A big congratulations to all those who won. We also would like to thank the community for getting behind this event in either buying raffle tickets, coming to the morning tea or both. Without your continuous generosity and unwavering support for the CWA we would not be able to hold events like this and hope you will all join us and have fun.

We would like to thank those people who generously donated to the CWA, we really appreciate your support and hope to continue the relationship the CWA has with the community.

Lastly, we would like to thank Diane Colebrook. You have gone above and beyond in what you have done, all the prizes that you have donated and you time that **you have given. We can't begin to tell you how much we appreciate what you have done but be assured that we are very appreciative of everything that you have done for the CWA. Thank you, thank you, thank you!!!**

Once again, a huge thank you to all those who helped, attended, bought tickets or just donated. Your generosity and support the CWA will not go unnoticed.

Stay tuned for future events!!!



# **AVONDALE MACHINERY MUSEUM**

**COMMUNITY FEEDBACK IS SOUGHT ON THE COLLECTION AT AVONDALE.**

**QUESTIONS INCLUDE - SHOULD IT REMAIN AT AVONDALE OR SHOULD STEPS BE TAKEN TO MOVE IT TO TOWN?**

**DOES THE COMMUNITY VALUE THE COLLECTION?**

**THE REPORT PREPARED FOR COUNCIL & COMMENT FORM IS AVAILABLE FROM THE SHIRE OFFICE OR WEBSITE.**

**PLEASE COMMENT BY 30 JUNE 2021  
ADMIN@BEVERLEY.WA.GOV.AU OR DROP OFF IN PERSON AT THE SHIRE OFFICE**



BEVERLEY HISTORICAL SOCIETY presents "Olden Days" by Y2 BDHS

Last Monday my class went to the great Dead Finish Museum. It was Year 2 only and the teachers. The Dead Finish is a museum with stuff from the past and even older stuff. First my group did silver polishing. I had to learn how to scrub silver without water and a sponge. Next I went to the dress ups. I put on a dress and gloves with a handbag. Then we went to the school and wrote with nib pens and ink wells. Lastly we went to the washing and we washed the clothes with soap and our hands to wring them out. Finally we enjoyed the refreshments and lollies and we got a souvenir. I had a great time with the helpers and the class teachers too. My favourite part was looking at the gardens and the gates and eating the lollies.

By Jade



Last Monday my class went on an excursion to the Dead Finish, it is 150 years old. First my group did silver polishing. We did lots of polishing. Next we went to the dress ups. We tried on all the old clothes. Then we went to the old school. At the school we got to use a nib pen. Lastly we went to the washing. At the washing we got to clean all of the clothes. Finally we were given some refreshments; they also gave us a penny and some lollies. We had a great time with the ladies. My favourite part was dressing up.

By Claire



Last Monday my class went on an excursion to the Dead Finish; the Dead Finish is full of old things. First my group did washing. We learnt to wash. Next we went silver polishing. Then we went to dressing up. I liked trying on the old clothes. We tried on old clothing, we tried on old hats and old things. Lastly was school, we used an ink pen and paper and we saw a strap and a cane. Finally we were treated to refreshments, I loved everything we ate. We were given a penny which was old and we were given lollies. I had a great time at the Dead Finish. My favourite part was everything

. By Carrie

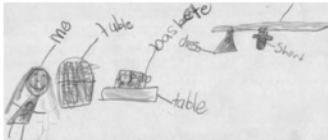

Last Monday my class went on an excursion to the Dead Finish. The Dead Finish is a museum. First my group did dress ups; I loved it! We tried on old clothes. Next we went to the old school. I sat at the old desk and used an old nib pen that was old. Then we went to washing. We washed clothes and pegged the washing in on the old washing line. Lastly we did polishing. I polished a spoon and a plate and made them shiny. Finally we had refreshments. I had a great time, it was the best.

By Bella

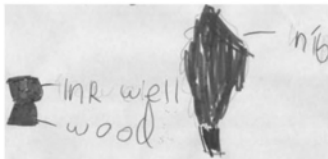

On Monday 22<sup>nd</sup> March the year 2 class went to the Dead Finish Museum. It is 150 years old today. First my group did dress ups. We tried really old clothes. Next we went to the old school. I loved using the nib pen. Then we went to washing. We had to rinse the clothes in water then put soap all over the clothes. Next we scrubbed clothes. Next we put it in the blue. Lastly I put it in a basket and grabbed a peg and we put it on a rope. Lastly we polished silver and I had the hardest and that is what I liked the best. Finally we go treated with refreshments. Thanks to the volunteers for sharing their time and showing us through.

By Alec



*My class went on an excursion to the Dead Finish. The Dead Finish is 150 years old. We wrote with a nib pen. We washed the clothes.*

By Jerrell



Last Monday my class went on an excursion to the Dead Finish museum. It is 150 years old. First my group did silver polishing. Next I went to dress ups. Then I went to the school and I used a nib pen. Lastly I went to the washing and put it in the blue water. Finally we were given refreshments, a penny and lollies. We were lucky we got refreshments. My favourite station was polishing my spoon.

By Dakota



Monday 22<sup>nd</sup> March the year 2 class went to the Dead Finish. The Dead Finish is 150 years old. First my group did school and used a nib pen with ink to write on paper. Next we went to washing and washed some clothes and hung them up. Then we went to silver polishing and used a toothbrush to scrub the silver. I did dress ups and tried a dress and hat. Lastly we went to the garden and saw the old fences. Finally we had refreshments and lollies and green cordial. They gave us all a penny. I had a great time. I loved it. My favourite part was the washing.

By Kaitlyn



*Last Monday my class went to the dead finish museum. First I went to the school room. Then I went to the washing. Then we did the cleaning and then I did dress ups. My favourite part was writing with a nib pen.*

By Alice





On Monday the 22<sup>nd</sup> of March and the year was 2021 the year 2 class went to the Dead Finish Museum. The Dead Finish is a museum and it is 150 years old and inside is stuff from the past. First my group went and did silver polishing. I learnt to polish silver stuff with Silvo. Next I went to dress ups. Then we used a nib pen in the school room. Lastly my group went to wash clothes. I washed long pants and shorts and I got to hang it out and dip it in the blue water and rinse it. Finally we got to enjoy the refreshments that the ladies gave us and gave us one penny each. I had a great time and the volunteers were very helpful. My favourite thing was washing the clothes and hanging them up.

By Heidi



Last Monday my class went on an excursion to the Dead Finish Museum. The Dead Finish is 150 years old this year and inside is stuff from the past. First my group did Silvo and it was stinky. I learnt to polish silver stuff with Silvo. Next we went to dress ups. Then we went to school room. Lastly we did washing. I learnt how to wash in the past. Finally we were given refreshments. I liked the green cordial and they also gave us a souvenir. It is called a penny.

By George

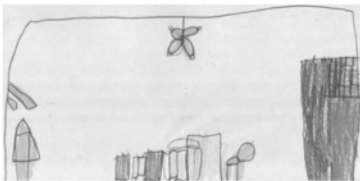

On Monday 22<sup>nd</sup> March the Year 2 class went to the Dead Finish. The Dead Finish museum has a lot of old things. First my group did school. We had to draw with a nib pen. Next we did the washing line. Then we went to the polishing. Lastly we did the dress ups. We put the powder on our faces and we put the dresses on too. Finally we did eat the snacks. We had drinks and we were given a penny and some lollies. At the end we went back. My favourite part was the school.

By Sasha



On Monday 22<sup>nd</sup> of March my class and I went to the Dead finish Museum. The Dead Finish is a museum with old things and this year it is 150 years old. First, my group did the washing with no washing machines. We had to scrub and soak and put it in the blue. Next we went to silver polish. We had to scrub with Silvo on a cloth. Then we went to dress ups. I liked putting on the fluffy coats and dresses. It was very fun. Lastly we went to the school room. We used nib pens and saw the cane and the strap. Finally we were given refreshments. I liked the fairy bread. We got a penny and lollies. We were very lucky that the volunteers were there. My favourite part was using the nib pen.

By Sienna

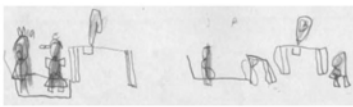

On Monday 22<sup>nd</sup> March the Year 2 class went to the Dead Finish 150 years. First my group did dress ups. Next we went to school. Then we did washing lastly we did silver polishing. Finally, we had refreshments. And we got a penny and lollies. We were very lucky. My favourite part was dressing up

. By Cherrie



Last Monday my class went on an excursion to the Dead Finish. The Dead Finish is a museum. First, my group did the washing. I learnt how to do the washing. Next, I went to the silver polish. I learnt how to polish trophies. Then, I did dress ups. I tried on woolly clothing. Lastly, I went to school. I used a nib pen. Finally, we enjoyed refreshments, they gave us a penny and some lollies. My favourite part was using the nib pen.

By Phoebe



Last Monday the Year 2s went on an excursion to the Dead Finish. The Dead Finish is a museum that is 150 and has old stuff. First I did dress ups and touching the fur. Next we went to the school. I wrote with a nib pen. Then we went to washing and put the clothes in the blue water. Lastly I did polishing plate and a cup. Finally, I was treated with refreshments and we got a penny and lollies. I had a great time. The volunteers were handy. My favourite part was writing with a nib pen at the school.

By Mia



On Monday 22<sup>nd</sup> March the year 2 class went to the Dead Finish. The Dead Finish is a museum full of old stuff. First my group did washing. We learnt to do washing without using a washing machine. Next we went to the Silvo. I like to polish with it. Then we did dress ups in fancy clothes that are old clothes. Lastly was school and we used nib pen and we saw the strap. Finally we enjoyed refreshments. I liked the fairy bread.

By Stella



Last Monday the year 2 went on an excursion to the Dead Finish. First my group had dress ups. Next we went to the school room. Then we did washing. Lastly we polish the silver.

By Joseph

First my group went to school. We wrote with a nib pen and ink. Next we went to washing and put it in some blue water and shook it out to dry. Then we polished silver. I polished a plate. Lastly, we did dress ups.

By Kyemelo



# Beverley District High School

Independent Public School

*'Working in Unity to make a difference for every child'*

*BDHS sits on the lands of our Noongar people and we acknowledge them as the traditional custodians of the Ballardong region.*

For more information about the school, visit our website and Facebook page!

## BDHS – Our Town, Our Country Podcast

Mrs Sarah Aynsley has been working with our Year 3-6 Talented and Gifted Students (TAGS) who have been interviewing local residents for our podcast, *'Beverley District High School - Our Town, Our Country'*. The students have created multiple episodes and they have been uploaded to Podbean. You can download the Podbean app and subscribe, so you don't miss any of our stories! <https://beverleydhs.podbean.com/.../the-history-of-.../>



👉 Tune in to hear Abigail speak with Mrs Mary Blechynden, the **Beverley Tennis Club's** only female life member, speak about her memories and love of tennis in Beverley. Refer to Episode 7.

### Episode 2 📖

*Recorded and produced by Charlie and is about the history of policing in Beverley. Take a listen as she speaks with Mrs Natalie Kilpatrick and Sergeant Darrell Hagan and explores how policing has changed in our district.*



A Conversation with Jenny by Oliver

### Junior Football in Beverley by Hamish



### More episodes uploaded:

- Noah - The History of the Avon River
- Burke - Farming Enhancements in the WA Wheatbelt
- Ruth - The story of Sunset Hill
- Nikita - The History of My House on Forrest St
- Owen - The Beverley Fire Brigade
- Jacob - The History of the Beverley Town Hall
- Katerina - Wildflowers of Beverley
- Theresa - The Story of Beverley DHS
- Darcy - Avondale Farm

[www.beverleydhs.wa.edu.au](http://www.beverleydhs.wa.edu.au)

Phone: 96462500

## Mother's Day Celebrations in Kindy and Pre Primary

Our Kindy and Pre Primary students enjoyed hosting Mother's Day Evenings for their Mum's and Nana's in Our Early Learning Centre. Mrs Hawke and Mrs Higgins organised some lovely activities for all to enjoy in Building A, whilst Mrs Kilpatrick and Mrs Tilley had some wonderful pampering and fun activities set up for all of the mums to enjoy with their child. All mums received a lovely gift to end the evening, made by their child, for their mum with love! It was so lovely to see our students so excited to have their special people in their classroom. Another great BDHS tradition of life as a Kindy and PP student and mum!



[www.beverleydhs.wa.edu.au](http://www.beverleydhs.wa.edu.au)

Phone: 96462500



# Truck Licence Training

## DATES

09-20 August 2021

HR Training & Assessment .....	\$1500
HC Training & Assessment .....	\$2275
MC Training & Assessment .....	\$2375

- Due to changes in the licence system, more training is required prior to assessment, and as a result of this costs have increased.
- All assessments are now video recorded as per Dept of Transport regulations.
- If a HR licence has been held for 12 months or more, you can upgrade to MC.

## How To Register Your Expressions of Interest

A minimum number of 5 people will be required to run each course  
(5 for HR, 5 for HC/MC).

Please contact the Beverley CRC to register your details on 9646 1600 or email  
[adminbcrc@westnet.com.au](mailto:adminbcrc@westnet.com.au)





## NEIGHBOURHOOD CENTRE WEEK 2021

# GOOD THYMES IN THE GARDEN

What a fun week we all had celebrating Neighbourhood Centre Week, if you missed out here's a line up of what we got up to!

What a Pile of Compost was so much fun as our composting queen Mandy Evans showed us how to build a steaming 1.5 metre compost pile using materials laying around our gardens. Our very own handywoman aka Trainee Jaime, showed us how to build composting areas at home, from pallet designs to small container designs.

I Spilt My Pants was our propagating workshop with indoor plant specialist Amor, who showed us how to easily propagate using water and a glass jar. Betty and Kate showed everyone how to propagate hardwood plants including roses, rosemary and many more and encouraged everyone to have a go. We were lucky to go home with many cuttings thanks to the generosity of the Community Garden volunteers.

What To Do with Your Poo was definitely the stinkiest workshop and our lucky poo expert Sam got down and dirty, creating blended manures from local farms. Unfortunately there wasn't any volunteers wanting to help with everyone quite content to just watch this one. Jaime took over and showed us how to make poo tea.

Squirm with the Worms was an interactive workshop hosted by the team at The Worm Shed. Kevin demonstrated how to build and look after a healthy and thriving worm farm and how to use the worm juice and castings in our gardens.

You Swapped What? Was an informal activity inviting all community members to come along and swap plants, seedlings and seeds with others whilst enjoying a scrumptious Devonshire Tea. Congratulations to Robyn Cashmore who won the gardening raffle.

We would like to thank the event supporters, CRC staff and committee and the volunteers at the Beverley Community Garden for all their work over the week.





# Valenti Lawyers Are Now In Northam

valentilawyers.com.au



Valenti Lawyers is a boutique law firm which prides itself on providing a personalised quality legal service. We specialise in eight core services for leading businesses and individuals, each led by one of our experienced senior lawyers; Business Growth & Protection, Dispute Resolution & Commercial Litigation, Finance & Security Services, Insolvency, Land Reservation, Resumption & Compensation, Property & Town Planning, Rural Assets & Succession Planning, and Wills, Probate & Inheritance. You can now find us at the below address in Northam every fortnight!

**Open fortnightly from the 12th February 2021.**

Please head to [valentilawyers.com.au](http://valentilawyers.com.au) to view our Northam office dates, and to book an appointment with one of our staff.

**RSM  
210a Fitzgerald St East.  
Northam WA 6401**

## Media Release



### Local practice receives the mark of quality as an accredited practice

Beverley/Brookton WA increased its community health credentials on 05/05/2021 when Vines Medical Practice received a national award of accreditation, demonstrating its commitment to quality and safety within its practice.

Vines Medical Practice received this important recognition from *Australian General Practice Accreditation Limited* (AGPAL), the leading not-for-profit provider of general practice accreditation services within Australia.

AGPAL Chair, Dr Richard Choong, said accreditation shows that the practice makes a significant investment and commitment to quality on a day-to-day basis, across all levels of the practice team.

"Achieving accreditation is a major achievement for any practice and a clear demonstration that Vines Medical Practice is striving to improve their level of care to both patients and the community," he said.

"Practices seek accreditation because they want to do their best and view this as another step towards excellence in patient care."

To achieve accreditation, a practice team works over a 12-month period to implement the *Royal Australian College of General Practitioners (RACGP) Standards for general practices*. The RACGP Standards provide a recognised national benchmark for general practices and services, and a template for quality care and risk management.

The AGPAL accreditation program supports general practices across the primary healthcare sector to provide a range of minimum expectations for patients surrounding safety and care. The accreditation process involves an independent on-site assessment of the practice's environment and their processes. Accreditation was developed jointly by AGPAL and primary health organisations and peak bodies, including the Australian Medical Association (AMA).

Areas of focus during an on-site assessment for accreditation include: ensuring vaccines are within their use-by-date and stored at the correct temperatures, that the practice's equipment is clean and sterile, practice staff are up-to-date with their training, and the practice has emergency care available.

Dr Choong said accreditation is attainable only through cooperation and communication between staff members.

"Everyone at the practice plays a valuable role in working to meet the RACGP Standards. It gives staff a real sense of pride to work in an AGPAL accredited practice," added Dr Choong.

Vines Medical Practice proudly displays the AGPAL accredited symbol for all their patients to see.

"We want community members, nationwide to know that their wellbeing is our priority. By choosing to attend an AGPAL accredited practice, patients know they will get quality and safe care that meets the RACGP Standards."

Vines Medical Practice located at 135 Vincent Street, Beverley and 12 William Street in Brookton offers highest quality, personalised, patient centred care from general medical consult, immunisation-routine childhood immunisation, influenza /COVID19 vaccinations, men's health, women's health - Implanon/Mirena insertion/removal, child health, skin cancer clinic and our new aesthetic clinic is coming soon.

**Contact us on 9646 1125 or 9468 3606**

**[www.vinesmedicalpractice.com](http://www.vinesmedicalpractice.com)**

AGPAL is the leading not-for-profit provider in general practice accreditation services; for further information on AGPAL please visit [www.agpal.com.au](http://www.agpal.com.au) or free call 1300 362 111.

# Station News



The Station garden is available for public use at any time;  
just open the gates and enjoy!

## COVID-19:

Please practice good hygiene and physical distancing at all our events, and use the hand sanitiser stations provided. If you are feeling unwell or have travelled outside WA in the 14 days prior to events at the Station, please do not attend.



## Artists-in-Residence at the Station Gallery

### *Artist in Residence*

During the month of May we had portraitist Kath Moore working from the station Gallery, (see pic at right with Britt Hadlow and her portrait). Kath was thrilled at the number of people wanting their portrait painted, and the number of visitors who came to the Station to see her work.



And then for the second half of the month, Nancy Ballesteros and Kathy Allam were artists-in-residence with their eclectic creative skills. Nancy sold many of her beautifully dyed silk products, as well as her exquisitely coloured wool and worked on some felting. Kathy



worked on her recycled lace shoes. See pic left, and above right Nancy demonstrating the felting technique to visitors.

**Artists in Residence for June** will be Irene Osborne for the first two weeks of June, and Stephanie Boyle for the remainder of the month. Please make them feel welcome.



**Irene Osborne** is a multi-award winning, professional Perth artist and has worked with all mediums and held many solo exhibitions since the early 90s. Her public art projects and commissions span across 25 towns/suburbs in WA.

Whilst in Beverley she will be painting just for the pleasure of it and welcomes people to the station to chat and paint with her there. Irene also loves plein air painting and being out in nature so she'll probably be looking for some old gnarly trees or blackboys/grasstrees which always inspire her.

A visit to the gallery will not disappoint as she will have paintings on display, and if any older folk (their faces have life etched on their features) would like to sit for their portrait, please also drop in to make a time.



**Stephanie Boyle** is an award-winning artist who has been painting watercolours for over 30 years. On nine occasions she has attended Charles Sturt Summer School in Bathurst, NSW to further her technical ability and has been tutored by Australia's leading water colour artists. Stephanie has taught watercolours at Claremont School of Art, Tresillian Art Centre, Canning Art Centre and Atwell Gallery. She has given numerous demonstrations to arts societies in WA, even giving a painting demonstration in Italy.

Whilst in Beverley she is hoping to do some plein air painting weather permitting. When at the Station she will be working towards an Exhibition coming up next year. At the Station Gallery will be her artworks for sale framed and unframed. Saturday 26th June at 11am Stephanie will give a demonstration of Painting

Watercolours on Yupo Paper. No charge.

Please keep an eye on the weekly Bulletin for further information regarding residencies, workshops or any changes to schedule to schedule - or contact A-i-R Coordinator Marylou on 9647 1027/0427 085 511 or email: [hutchinson@wn.com.au](mailto:hutchinson@wn.com.au)

### **Artists-in-Residence Programme for the remainder of 2021**

MAY: 01 – 15 Kath Moore

MAY: 17 – 31 Nancy Ballesteros and Kathy Allam

JUNE: 01 – 17 Irene Osborne; 18 - 30 Stephanie Boyle

JULY: 01 -20 Trish Davis; 22-26 Jane Etienne

AUGUST: Rod Brown

SEPTEMBER: Carollyn Rhodes-Thompson

OCTOBER: Alan Pickering

NOVEMBER: 1-14 Kelsey Diamond;

NOV: 15-22 Annis Woods; 24-30 Thelma Cluning

DECEMBER: Julie Parsons and Peter Clarke 1- 14



### **Beverley Amateur Dramatics (BAD)**

The play *Secret Bridesmaids' Business* was performed by our fabulous local drama club over four nights – **Friday 23 April, Friday 07 May, Saturday 08 May, and Sunday 09 May** to wonderful audience numbers – around 200 all up. Well done BAD actors – those monologues were truly amazing! The great costumes were the work of Kathy Kont, sound and lighting due to Riley Anderson, stage manager – Issy Freeman. And last but not least, congratulations to the director of the play Mark Kont for getting the show on the road in such a short period of time, and then having to relocate the whole set from the Platform Theatre to the Town Hall following two weeks break because of Covid restrictions and the weather turning cold. The performance was so professional it could easily have passed for a stage play in the city. See below the first performance at the platform Theatre, followed by scenes at the Town Hall.

If you would like to be involved in future productions, contact Britt Hadlow by email: [britt.hadlow47@hotmail.com](mailto:britt.hadlow47@hotmail.com) or [beverleyamateurdramatics@gmail.com](mailto:beverleyamateurdramatics@gmail.com)





The Cast of 'Bridesmaids': Joey Walter, Gemma Bovington, Britt Hadlow, Jo Sims, Jodie Bell, Darryl Sims, Issy Freeman



### **Beverley Station Singers**

The extra practice on May 05 paid off for the various performances at the Merredin Songfest 2021 on 14-16 May. There were ten choirs all up singing their hearts out at the magnificent historic Cummins Theatre, as well as various places around the town. Merredin's choir 'A Choired Taste' did an amazing job of hosting this huge event and deserved the accolade of Merredin's *Community group of the Year*.

Station Singers will continue to meet on a Wednesday every 2 - 4 weeks. Next sessions will be **June 06 and June 23 at 7pm**. Beverley's own, albeit smaller choir event, **CHOIR MUSTER** on Saturday 11 September 2021.

Singing is directed by the talented Kelly Newton Wordsworth, cost \$20 per night. Sarah Miller is coordinating singing so if you are keen to come along you can phone 0427 464 078.





Beverley Station Singers busking outside the Merredin IGA



We are taking a wee break till August/September in which time we will be organising the monthly program to take us through to next April. Hope to see you all back then! A peek at what is in store and save the date:

Sunday 08 August at 6pm – Miss Westralia (musical comedy)

Saturday 11 September at 2pm – VoiceMoves Choir Muster

Saturday 06 November at 8pm – Landslide Fleetwood Mac/Eagles tribute

Saturday 18 December – Community Christmas Party

### Volunteer Thank You

- to the wonderful volunteers who stepped in at the last minute to join the Station Singers at the Anzac Service - Alan and Vicki Primrose, Di Smith, Joy Smith and Daniel Lea
- to Mark Kont for playing keyboard at the Anzac Day Service
- to Joey Walter for juggling time to prepare a grant application whilst still rehearsing and performing in the BAD production
- to Lisa Green for volunteering her time to help with the recent grant project
- to Barry and Pauline Knight for always being available when things need fixing or items need to be purchased from neighboring towns
- to the BAD crew for donating profits from the drama production to BSA
- to the BSA committee for spreading themselves to work at the door and bar over the four nights of 'Secret Bridesmaid Business'

Jenny Broun, President Station Arts. 0419040063

### Station Gallery Open Hours:

11.00am – 3. 00pm

Thursday, Friday, Saturday and Sunday

**Post Script:** The artwork of the Overall Winner of the Beverley Art Prize 2021, *Treehouse By The Sea 1*, is now framed and hanging in the Station Gallery...worth a visit to see and appreciate this superb printmaking of artist Elmari Steyn

# NATWAY FURNITURE & CONSTRUCTION

ABN: 62 824 726 465

WAYNE & NATALIE ASHWORTH

Qualified Carpenter &  
Joiner Tradesman

General Building Work

Furniture Construction  
& Restoration

## CONTACT US

27 Brooking Street, BEVERLEY

Wayne 0417 973 415

Natalie 0429 491 039

natwayfc@bigpond.com

OPTOMETRIST  
AVAILABLE ON  
TUESDAY'S  
*in Beverley*



### Peter Tidman OPTOMETRIST

If you are over 65 years of age,  
you are entitled to a yearly  
bulk billed check-up.

We encourage you to keep  
on top of your eye health.

You can find us at the  
RSL Hall, 50 Forrest Street, Beverley.

Appointment bookings  
Please call Beverley CRC 9646 1600.

## A VIETNAM STORY for ANZAC DAY

Mike Collins stared down at the photo that lay there on his desk  
It was faded, tattered, dog eared, but that made it bother him no less  
He turned 71 a month ago and time was running out  
His peace of mind depended on removing any doubt

There were two men in the picture and one of them was him  
It was taken in the heat of battle in the Mekong Delta , Vietnam  
Fifty years of searching and he still just had a name  
Archie Wallace had just vanished, it seemed he'd not be seen again

There was no record of his passing in the files Mike reviewed  
No note of his expiry in any wartime news  
That was until this morning, and it happened quite by chance  
Mike saw the name on his TV screen, it was a momentary glance

He did not catch the story's context or any background to it  
But the mystery was at last unlocked, somehow he just knew it  
His secretary went to work to track the story down  
It was news from out of Perth, the big business end of town.

Mike had colleagues over there who would know the 'how and why'  
Was this Archie his man? Was he in trouble? Did he die?  
He called his friend Al Tennison, a well respected man in law  
Like Mike he was a Vietnam vet, a survivor of 'that' war.

Al told him that 'this Archie bloke' lives a hermits life alone  
Out there in the desert on a mining lease he owns  
"But the corporate mob are challenging.....his lease holds so much  
gold  
Archie's holding on for his grandkids, but he could lose it all I'm told"

"It's true he has a lease but it's validity's in doubt  
And the corporates are after it, they've brought their big guns out  
They'll fight it out in court in just a week or two  
Mike, I'm curious why this matter is of interest to you"

"I'm flying in tomorrow Al, I'd like an hour of your time  
I know that you are busy, I hope that you don't mind  
Could you set up a meeting between Archie and my crew?  
He's a fellow vet mate, we must do what we can do."

Mike now knew for sure that Archie was his man.  
After fifty years of searching he'd make good on his plans  
With a meeting set that afternoon Mike and Al put things in place  
And set the scene for Archie to meet them face to face

Archie walked into the room, confused about the fuss  
Mike and Al both shook his hand, between veterans total trust  
Mike took the picture from his wallet, Archie unfolded it and stared



Mike said "right to this day, I thank God that you were there"

Both men were emotional , neither knew quite what to say  
Archie wasn't one to seek the limelight anyway  
But Mike at last had found him and as karma played it's hand  
He said to Archie, "let me help you mate, listen to my plan"

Mike then said to Archie, "if it's ok with you  
I'll invite the TV people in, I'd like to give an interview"  
"I can do the talking, just sit back and take it in  
We've been in fights together....and this one we can win"

When the cameras started rolling Mike introduced himself  
"My name is Michael Collins of Collins, Jess and Phelps  
We are a firm of lawyers , and although I'm from the East  
I'll be representing Mr. Wallace re the retention of his lease"

"There will be no fee, not a cent to pay at all  
Archie is a hero , he went way beyond the call"  
Mike held up the picture for everyone to see  
"That soldier there is Archie, the one he's carrying is me"

"He was already wounded when he threw me on his back  
The battle raged around us, we were under full attack  
He carried me to safety, a chopper got me back to base  
Until today I'd not met Archie, I'd never seen his face"

"It was only through this picture that I finally got his name  
After fifty years of searching I met him here today  
I owe this man my life, I cannot repay that debt  
But if the corporates want a fight, it's a bloody fight they'll get!"

"All of our resources will be put to Archie's cause  
We'll take them on at every turn, we'll use every corner of the law  
As if Vietnam was not enough, it's time he got respect  
Let Archie Wallace keep his mine, it's the least he should expect."

That night on the news, it was very plain to see  
That Archie was a hero, a complete celebrity  
Mike got an email next afternoon, the corporates saving face  
Had decided that they'd no longer be pursuing Archie's case

It was sunset there at Scarborough as they enjoyed a beer or three  
Archie rolled a smoke, the sun dipped into the sea  
He stretched his legs and put his feet up on a nearby chair  
He said..."I'll tell ya what I reckon Mick, I think we'll call it square."

Author Bob Dungey  
Western Australian poet

*Irene Oram recited this poem by Bob Dungey at the 2021 ANZAC Day  
Morning Service in Beverley.*



**OP SHOP**  
**Open Friday's**  
**11.00am - 2.30pm**  
June Roster

June 04  
Ingrid Bell, Lee Storer,  
Pam Bradley

June 05  
Christine Brooke, Betty  
Wauchope

June 11  
Christine Brooke, Georgie  
Stone, Sarah Miller

June 18  
Glenda Burns Sue Eramiha,  
Valda Morton

June 25  
Donna Williamson, Dalene  
Davies, Jeanette Johnson

An advertisement for ChemDry Beta Finish. At the top, the ChemDry logo is displayed with the tagline 'Drier. Cleaner. Healthier.' and 'Beta Finish' below it. The central image shows a bright, modern living room with a white sofa, a coffee table, and large windows. In the bottom right corner of the image, the text reads 'Superior carpet &amp; upholstery cleaning'. At the bottom of the advertisement, the contact information is provided: 'Freecall 1800 017087', 'bettafinish@wn.com.au', and 'Fax 08 96225473'.

Established in 1997, proudly servicing Beverley and surrounding areas



## BEVERLEY GAS + PLUMBING SERVICES

PL 9723  
GF 017690  
BFL 3108

**Beverley Gas and Plumbing is your local plumber  
for all your plumbing and gas needs.**

- Renovations
- Septic and leach drains
- Gas installs and maintenance
- Hot Water
- Blocked drains
- Dripping taps
- Backflow prevention
- Sewerage conversion

# Kodie Fleay

## Phone 0418 929 141

Email [beverleygandp@gmail.com](mailto:beverleygandp@gmail.com)



101.3 FM  
**VOICE OF THE AVON**  
LOCAL RADIO PROGRAM

### SUNDAY

6.00–10.00 Sunday Breakfast - Terry  
 10.00–1.00 Easy Sunday - Denni  
 1.00–4.00 Teen Spirit – Gracie B

### MONDAY

6.00–10.00 Monday Breakfast - Bob  
 10.00–1.00 Monday am - Leslie-Ann  
 1.00–4.00 Round the Bend.  
 Over the Hill, Rhonda & KT  
 4.00–7.00 Celtic Note - Joe  
 7.00–10.00 Classical Sounds - Chris

### TUESDAY

6.00–10.00 Tuesday Breakfast - Bob  
 10.00–2.00 Country Roads - Joe  
 2.00–5.00 **Rockin' on the Avon** -Denni  
 5.00–7.00 Turn it up Tuesday – Michael

### WEDNESDAY

6.00–9.00 Sunny Side Up - George  
 9.00–1.00 A Little Bit of Everything – Joe  
 1.00–4.00 Potpourri - Peter  
 6.00–9.00 Back to the Future – Frank

### THURSDAY

6.00–9.00 Thursday Morning - Joe  
 9.00–12.00 Thursday am - Bob  
 12.00–3.00 Kaleidoscope – Chris  
 3.00–6.00 Drive - Graham  
 6.00–9.00 **Tonk'n along**-Tonks

### FRIDAY

6.00–10.00 Friday Breakfast - Bob  
 12.00–4.00 **Michael's Mix Up**- Michael

### SATURDAY

6.00-9.00 Saturday Breakfast - Nada  
 9.00–12.00 Spirit of the Music - George  
 12.00–2.00 Country Trax - Haydn  
 2.00–4.00 Saturday Mix – Graham  
 4.00-6.00 My Kind of Music–Lesley-Ann

Phone: Studios 9641 2422

Sponsorship: 0408 502 711

E-mail: [radio6yrc@hotmail.com](mailto:radio6yrc@hotmail.com)

Facebook

Voice of the Avon 101.3 FM – 6YCR  
(with live streaming)

[voiceoftheavon.org.au](http://voiceoftheavon.org.au)

live streaming- Voice of the Avon 101.3 FM

87 hours of local presenters each week  
Effective 06 April 2021

*Changes may be made without notice*

# SARAH SOMERS

## LAWYER

SERVING THE WHEATBELT COMMUNITY

Family Law - Divorce - Separation  
 Property Settlement - Restraining Orders  
 Defacto Relationships  
 Children's Issues - Contact/Residence  
 Competitive hourly rates  
 Reduced fee for Initial Consultation

 85 Fitzgerald Street, Northam WA 6401

 9622 9687

 [sarahsomers@iinet.net.au](mailto:sarahsomers@iinet.net.au)

Worried about banking  
in Beverley after  
September 2021?

Representatives from the  
Commonwealth Bank  
Northam will be at the  
Beverley CRC  
Wednesday 21 July  
and  
Thursday 22 July  
from 9.30 am – 3.30pm

Branch Manager  
Clara Watson and her  
team will be available to  
open accounts.

They offer a range of  
accounts that include being  
able to deposit and withdraw  
at the Australia Post.

Both personal and society/social  
accounts will be available.

Information on our various  
account options are available  
on [www.commbank.com.au](http://www.commbank.com.au) or  
by calling the Northam Branch.

Information to be provided  
soon regarding identification  
requirements that will need to  
be provided on the day.

If you wish to schedule an  
appointment time, please  
contact Clara (08) 96221277 or  
email on [watsoncl@cba.com.au](mailto:watsoncl@cba.com.au)



## CWA Beverley Branch

Very many thanks to our CWA members for their contribution to last month's Mother's Day raffle held at the CWA hall on the morning of Saturday 08 May, together with a Devonshire morning tea, where the freshly baked scones were snapped up rapidly, also our thanks go to Alan Primrose for his musical entertainment during the morning, it was incredibly hard for some of us not to sing along too.

The winners of the Mother's Day raffle were:

- 1<sup>st</sup>-Ellie Baldwin,
- 2<sup>nd</sup>-Kristy Dugan,
- 3<sup>rd</sup>-Linda,
- 4<sup>th</sup>-M Rohrlach,
- 5<sup>th</sup>-Pat Alexander,
- 6<sup>th</sup>- Lesley Heal, and
- 7<sup>th</sup>-Kayla Dean

We wish to give special thanks to Gary & Denise Ray together with Alan Primrose for drawing the winning tickets. We hope all the Mums had a beaut day (I know I did!).



Over the past few months Vicky has given us several educational talks about Japan, and at our monthly CWA meeting in May, some of the ladies brought in cherished items that were made there, each holding special family significance.

### Upcoming events

Our next social morning tea will be on Wednesday 02 June from 9.30am to 11.30am where all are welcome to pop in for a cuppa and a chat.

On Wednesday 16 June we will be holding our next CWA monthly meeting from 10.00am after which we will share lunch together.

In July we are hosting **Kings Park Fashions** who will be showing some winter garments, it is possible that some of the fashions will be shown off by locals who are willing. An update will be in the next Blarney so keep tuned.

For all CWA enquiries including hiring the CWA hall, please contact our President Pat Hambly or Wendy Hambly on 9646 1481.

## **BROOKTON PLUMBING**

ABN: 37 675 595 336

**FOR ALL YOUR  
PLUMBING MAINTENANCE  
AND GAS FITTING NEEDS**

**\*PLUS SEPTIC WASTE  
REMOVAL**

**PHONE:  
SEAN 0413 480 543 or  
NATASHA 0422 013 889**

**PL: 7130 GF: 006947 SWR: T235**

**ROYAL ANTEDILUVIAN ORDER  
OF BUFFALOES**



**GLE (Inc)**

**QUAIRADING BEVERLEY NO.163**

We meet the first Wednesday of every month at the Masonic Lodge, Hunt Road, Beverley

*The objects of our order are Philanthropy and Good Fellowship.*

For more info contact

Tom 0419 945 240



**Annual General Meeting of Electors**

Notice is hereby given that the Annual General Meeting of Electors for the 2019/2020 financial year will be held in the Cornerstone Community Centre, 141 Vincent Street, Beverley on MONDAY 14 JUNE 2021, commencing at 6.00pm.

Order of Business

1. Adoption of 2019/2020 Annual Report
2. General Business

As per Section 5.5 of the *Local Government Act 1995* copies of the 2019/2020 Annual Report are available from the Shire Administration Office, located at 136 Vincent Street Beverley, during normal office hours or on the Shire website.

To enable staff time to adequately research answers to questions, it would be appreciated if such enquires could be lodged at the Shire Office at least seventy two (72) hours prior to the scheduled commencement of the meeting.

STEPHEN P GOLLAN  
Chief Executive Office

OUR GROUP OF CARERS WORK WITH ANY WILDLIFE FOUND ON ROADSIDES

**WILDLIFE  
EMERGENCY  
RESPONSE WA**

We are a network of carers in Western Australia specialising in the rehabilitation of injured and orphaned wildlife.

Our team contacts

PHYLLIS FACEY 0437 483 175  
LYNN POWELL 0417 959 913  
SONIA COOKE 0423 806 757

**WESTDALE TIMBER**

T/A R. L. & T. L. TAMBLYN ABN. 106 854 06

**TREE TRUNKS REMOVED  
TIMBER SLAB SALES**

PLEASE DON'T BURN UP GOOD USEABLE TREE TRUNKS

SAVE THEM FROM THE CROPPING CLEAN UP FIRE

DON'T LET THEM ROT AWAY TO WASTE

I WILL CHAINSAW THE TRUNK OUT OF THE TREES

LEAVING THE BRANCHES FOR YOU TO PUSH ONTO STUMPS  
TO EASILY BURN UP

300MM AND LARGER TREE TRUNKS

WANTED DEAD OR ALIVE BY THE TRUCKLOADS

STANDING DEAD OR STORM WINDFALL TREES REMOVED

MARRI/RED GUMS, JARRAH, WANDOO/WHITE GUMS,  
SHEOAK, TUART, BLACK BUTT AND PINES

*Save yourself time and effort.*

**PLEASE CALL RICKY 0419 903 829**



**York Estate Agents  
(Beverley Division)**

**Good, Bad or Ugly We Sell!**

Free Appraisals

**"Properties WANTED we have qualified buyers waiting now"**

**Estate Experts**

**Professional and Trustworthy**

Residential and Rural - Mike Bawden

**0403 268 158**

Rentals - Jenette Callaghan

**0418 929 011**

Office - 9641 1335

Email: [yorkfn@westnet.com.au](mailto:yorkfn@westnet.com.au)

[www.yorkfn.com.au](http://www.yorkfn.com.au)



## PLAYGROUP SESSION DETAILS



**When:** Thursday  
morning's  
(closed on school &  
public holidays)

**Time:** 9.30am to 11.30am

**Where:** at the Playgroup  
Building at the Beverley  
School (Lennard St)

Available for all children  
aged 0-4 years old

Bring a piece of fruit to  
share, hat and sunscreen

### Weekly gold coin donation for Term 4

#### Annual Fees

Family - \$35 for Insurance

Concession card holders -  
\$15 for Insurance

Find us on Facebook:  
[Facebook.com/  
BeverleyPlaygroupWA](https://www.facebook.com/BeverleyPlaygroupWA)

For more information  
contact President  
Kelly Aaron 0400 772 081



## Beverley Garden and Tree Society



The May meeting was held at the Dead Finish Museum. Members discussed the pending closure of the ANZ bank branch in Beverley which is causing great concern for many of our members and the community generally.

The Agriculture show has yet to announce this year's show theme but we need to start potting up some plants for use in our exhibit. The town hall has been booked members reminded that we will have a display of teapots to add interest plus we need donations of books, bric-a-brac and plants for sale.

Our next meeting will be held at the Dead Finish museum on Tuesday 01 June at 10.30am. We will have a guest speaker, Dave Hardy, to give us information about bee keeping. As always there will be a "bring and buy" table.

The weather is getting colder and the days shorter but there is still plenty of gardening in June.

#### Vegies to plant in June

Asparagus, broad beans, cabbage, celery, artichoke, lettuce, onion, peas, spinach spring onions and strawberries.

#### Flowers to plant in June

Alyssum, calendula, pansy, dianthus, viola, primula, carnation, cornflower, poppy, snapdragon and stock.

June is a great time to attend to the following tasks in the garden:

- Ensure reticulation is turned off
- Cut back butterfly bush (Buddleja) to one third it's size to keep if compact
- Lift and divide clumps of ground covering native violet and replant them in shady areas
- Give lillypilly and Westringia hedges a light trim to tidy for winter
- Tidy up and reshape overgrown hibiscus and crepe myrtle. Plan to give them a more serious prune in August
- Put potted cyclamen outside at night to enjoy the cool air
- Don't forget to check that your potted plants and gardens under eaves are getting enough water
- Once the leaves die down it is time to harvest onions, shallots and garlic
- Don't let beets get too big as they are sweeter when small
- Harvest spring onions and leeks as you need them as they do not store well
- Pick peas daily to encourage continuous crops. They are ready when the pods look plump
- Harvest rhubarb after the plant's first year, taking no more than half the stems. Hold stems near the base and twist
- Collect, bag and bin diseased foliage on fruit and veggies to reduce spread

Happy gardening!



## THE BLUE LINE

Beverley Police Station

57 Hunt Road Beverley WA 6304 [BeverleyPol@twitter.com](mailto:BeverleyPol@twitter.com)

Email: [Beverley.Police.Station@police.wa.gov.au](mailto:Beverley.Police.Station@police.wa.gov.au)

### IS YOUR FIREARM LICENCE OVERDUE??

For those of you with firearm licences, it is extremely important to ensure that you have a current licence. A firearm licence is only valid for a year, so you need to make sure you know the expiry date and renew the licence before expiry.

The renewal licence will be forwarded to your last known postal address and it is up to you to ensure that police have the current address for the renewal to be posted to.

If you fail to renew your licence after 3 months of expiry then an infringement will be issued. This is personally served on you by police. The cost of the infringement is \$421.00.

If you fail to pay the infringement then you will be charged by police and have to go to court.

If you have any queries in relation to your firearm then contact Licensing Service on 1300 171 011.

If you want to know your licence expiry date then go online to <https://publiclicensingportal.police.wa.gov.au/home> and add all your details and it will give you the expiry date.

### MOVEMENT OF AGRICULTURAL VEHICLES/IMPLEMENTS

It's that time of year again where there is an increase on the roads of agricultural vehicles and implements. Below is the Agricultural Pilot Requirements flow chart for when you require a pilot vehicle and what is required of a pilot vehicle and oversize vehicle. It is not exhaustive so if you require any more information then Heavy Vehicle Help Desk on 138 486 or visit the Agricultural Vehicles page of our website at [www.mainroads.wa.gov.au](http://www.mainroads.wa.gov.au)

#### PILOT AND ESCORT VEHICLES

- A pilot vehicle must have 4 or more wheels and a GVM of:
- (a) 6.5 t or less in the case of a rear pilot vehicle, if 2 pilot vehicles are required; or
- (b) 4.5 t or less in any other case.
- A pilot vehicle must have a warning sign on its roof.
- A pilot vehicle must only have an amber flashing warning light:
- (a) above or below the sign; or
- (b) at each side of the sign.
- The headlights or day running lights on a pilot vehicle or escort vehicle must be switched on when it is accompanying an oversize vehicle.
- A pilot vehicle must not tow a trailer or carry a load, but it may carry tools, equipment or substances for use in connection with the oversize vehicle it is accompanying or for restraining the load on that oversize vehicle.
- When one pilot vehicle accompanies an oversize vehicle, the pilot vehicle must travel:
- (a) behind the oversize vehicle, if they are on a road with multiple lanes, in the direction of travel; or
- (b) in front of the oversize vehicle, if they are on a road that is only a single lane, in the direction of travel.
- When 2 pilot vehicles accompany an oversize vehicle, one pilot vehicle must travel in front of the oversize vehicle, and the other behind it.

## BEVERLEY STORAGE & TOWING

HUGE NEW PREMISES LOCKED & FENCED

\$100 A MONTH CARS, CARAVANS, BOATS, MOTORHOMES WE HAVE ALL OF YOUR STORAGE NEEDS COVERED.

TILT TRAY WITH WINCH CAR TRAILER PICK UP AND DELIVERY - ALL AREAS

**BRETT HIGGINS**  
0400 048 976  
[beverleystorage@hotmail.com](mailto:beverleystorage@hotmail.com)  
[www.facebook.com/BeverleyStorage](http://www.facebook.com/BeverleyStorage)



## VALLEY AIR CONDITIONING & REFRIGERATION

0408 755 466

Supply and Installation of all types of air-conditioning and refrigeration systems. Split, Ducted, Evaporative, service and repair to domestic, industrial and commercial.

Throughout the Avon Valley and Wheatbelt, no job too far, call Mark for a free quote

Email [valleyaircon@outlook.com](mailto:valleyaircon@outlook.com) ARC Lic AU42118



- A pilot vehicle must travel far enough away from the oversize vehicle it is accompanying to give adequate warning to other road users of the presence of the oversize vehicle, taking into account the type of vehicles that use the road, traffic speed, weather, visibility and other driving conditions.
- An oversize vehicle and any accompanying pilot vehicle or escort vehicle must have an electronic device that allows the drivers to communicate effectively with each other.
- A pilot vehicle that accompanies an oversize vehicle must only be driven by a person who is the holder of a "heavy vehicle pilot licence" and is declared as an "Authorised Person", unless otherwise authorised.
- The driver of a pilot vehicle and the driver of an escort vehicle must inform themselves of the dimensions, warning devices requirements, driver requirements and relevant vehicle operational requirements including conditions of permit, prior to accompanying the oversize vehicle.
- The driver of an oversize vehicle must comply with any lawful direction or signal given by the driver of the lead pilot vehicle or, if accompanied by an escort vehicle, the Traffic Escort Warden.
- The driver of a pilot or escort vehicle must not operate any other vehicle or machinery, such as steer a platform or jinker trailer, whilst accompanying an oversize vehicle.
- To avoid unnecessary traffic build up, an oversize vehicle accompanied by a pilot vehicle must pull over on a regular basis to allow traffic to pass. This includes stopping in all parking bays that are suitable and stopping wherever it is safe to do so, with pilots or Traffic Escort Wardens providing traffic management if necessary.
- The flash of an operational amber warning light must be visible between 120 and 200 times a minute, in normal daylight, at a distance of not less than 500 metres in any direction.
- Where it is not possible to see one warning light mounted on the vehicle or load from any direction, additional amber warning light(s) must be mounted on the vehicle or load.
- A pilot vehicle travelling in front of an oversize vehicle, may place a filter behind the warning light on the pilot vehicle to reduce the intensity of the light directed to the driver of the oversize vehicle.
- Any warning light which a pilot vehicle or escort vehicle is required to have must be switched on when the vehicle is accompanying an oversize vehicle.
- If a vehicle is not required under the operating conditions to have a warning light, it must not have one that is switched on.
- Wig Wag lights must only be used where stipulated in the conditions of a permit or order. Wig Wag Lights:
  - (a) Must be mounted in pairs, one on each side of the front of the vehicle;
  - (b) Must flash an alternating white light;
  - (c) Must not interfere with the amber warning lights or any other lights required under road law;
  - (d) Must not be headlights;
  - (e) May be spotlights with a maximum output of 55 watts, provided they are angle down 45degrees toward the road surface;
  - (f) May be LED day running lights, provided the light emitted from each lamp does not exceed 400cd;
  - (g) Must have an illuminating surface area not less than 40cm<sup>2</sup>;
  - (h) Must be no less than 500mm above ground level and no more than 1000mm aboveground level.
- The face of a warning sign must have a yellow surface.
- The face of the warning sign must have a black border at least 20 mm wide. The border may be split if the sign is divided into two parts.
- The outermost edge of the border must be set at least 10 mm in from the edge of the sign unless the sign has been made with a box edge.
- The warning sign must display the manufacturer's name or logo, and the brand and class of retro

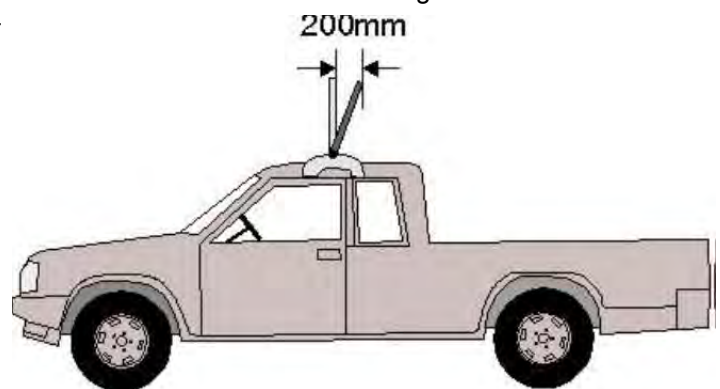

**PURSLOWE TINETTI**  
**FUNERALS .com**



*Cremations & Burials*

*Country or City*

*Pre-paid Funerals*

*Arranged in your home or*

*264 Fitzgerald St Northam*

**Call the Tinetti Family**

**9622 1411**



AUSTRALIAN  
FUNERAL  
DIRECTORS  
ASSOCIATION

- reflective material used in block letters at least 3 mm, but not more than 10 mm, high.
- The marking may appear in any visible location on the sign, except in a bottom corner of a sign used on a pilot vehicle.
- The face of the warning sign must be appropriately maintained to ensure it is clearly visible and legible to other road users.
- A warning sign must be made of either:
  - (a)stiff, flat, weatherproof material, or
  - (b)flexible material, provided the sign is held taut, and is clearly visible and unlikely to be come dislocated, furl or otherwise become difficult to read by other road users.
- A flexible warning sign that is in such condition or state that its message cannot be easily read by other road users is deemed not to be a warning sign for the purposes of this Section.
- A warning sign must not be displayed on a vehicle that is not an oversize vehicle or a pilot vehicle.
- A warning flag must be brightly coloured red, yellow, or red and yellow, at least 450mm long and 450mm wide.
- A warning sign on an oversize vehicle must be at least 1020 mm long and at least 250 mm high.
- The sign may be split into 2 parts, in which case the combined length of its parts must be at least 1020 mm.
- A warning sign on an oversize vehicle must show the word "OVERSIZE", in black upper-case lettering.
- The lettering must be at least 180 mm high.
- If the sign is split into 2 parts, the part mounted on the left must show the letters "OVER" and the part mounted on the right must show the letters "SIZE".
- A warning sign on an oversize vehicle must be mounted vertically.
- The lower edge of the sign must be:
  - above the bottom of the bumper bar; or
  - if there is no bumper bar, at least 500 mm from the ground level.
- If the sign is split into 2 parts, each part must be fitted at the same height as the other.
- A warning sign on a pilot vehicle must be at least 1200 mm long and at least 600 mm high.
- The sign may have bottom corner cut outs not more than 150 mm wide and not more than 100 mm high, if they are needed for mounting the warning lights.
- Both faces of a warning sign on a pilot vehicle must show:
  - the word "OVERSIZE", in black upper case lettering at least 200 mm high, and
  - (b)the words "LOAD AHEAD", in black upper case lettering at least 100 mm high.
- The bottom of the lettering of the word "OVERSIZE" must be at least 300 mm from the bottom of the sign.
- The bottom of the lettering of the words "LOAD AHEAD" must be at least 100 mm from the bottom of the sign.
- A warning sign on a pilot vehicle must not lean back so there is more than 200 mm measured horizontally from the top of the sign to a vertical line running through the bottom of the sign.

### BEVERLEY POLICE – HOW TO CONTACT US

Life threatening or an emergency dial **000**

For all other matters phone **131 444 or 9646 3333**.

If it's not urgent send us an email [Beverley.Police.Station@police.wa.gov.au](mailto:Beverley.Police.Station@police.wa.gov.au) or leave us a message on twitter [@BeverleyPol](https://twitter.com/BeverleyPol)

Please take care and stay safe.

Sergeant Darrell Hagan and Senior Constable John Lines

All types

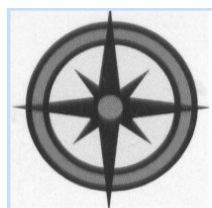

All areas

## ALLROUND CONCRETE

**SHED FLOORS, DRIVEWAYS, FOOTPATHS, HOUSE SLABS,  
SILO PADS, FERTILIZER/GRAIN/SUPA SHEDS**

**ROBBIE HIGGINSON**

**MOBILE: 0427 384 977**

**HOME: 9641 2459 FAX: 9641 2339**

**ABN: 26 997 512 874**

**Po BOX 345 YORK WA 6302**

## DJ YATES

**Authentic Heritage Restoration**

**BRICK AND STONEMWORK  
RESTORATION  
AUTHENTIC REPOINTING OF  
MORTAR, RISING  
DAMP RECTIFIED  
PROPERTY  
MAINTENANCE**



**PHONE DAVE**

**0419 041 542**





# Agricultural Pilot Requirements

**Start**  
How big is your agricultural vehicle? ("vehicle" includes a machine, implement and combination)

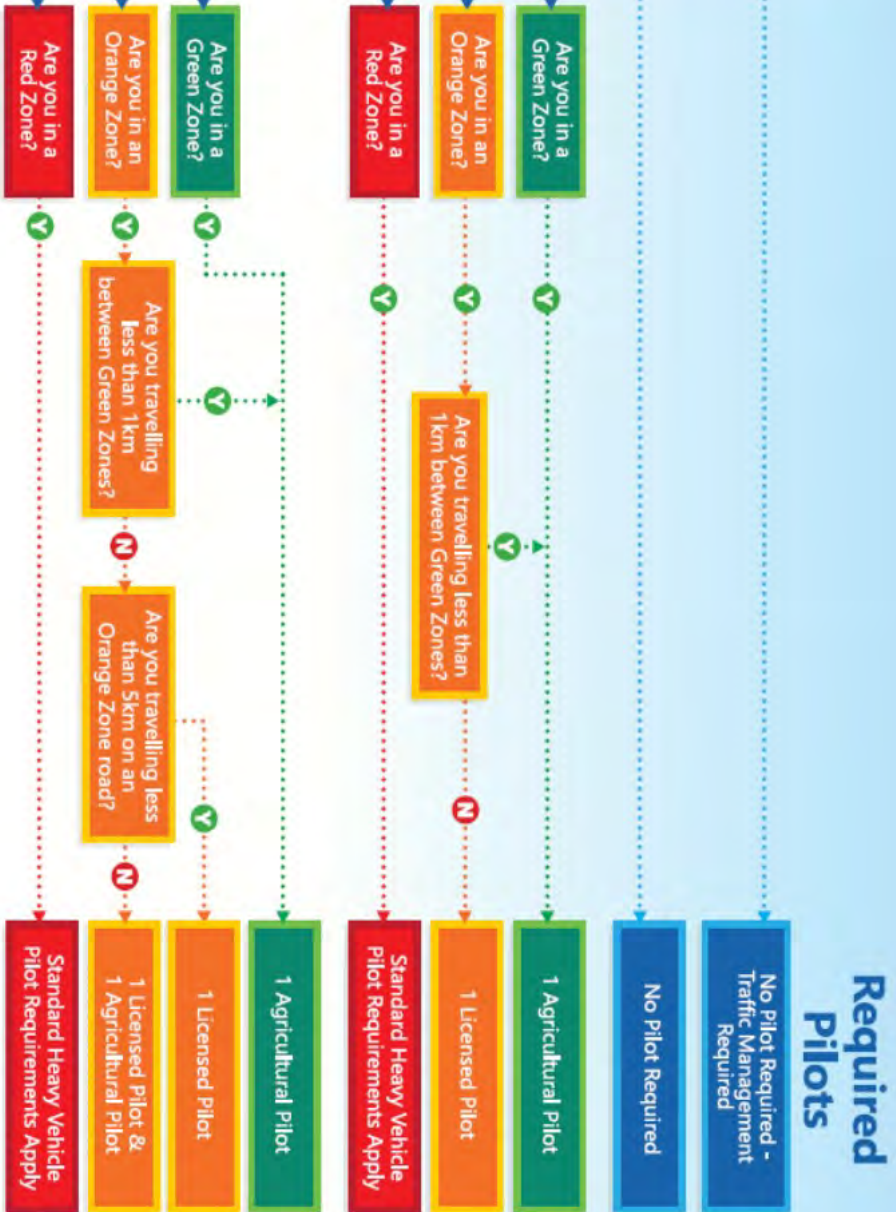

**NOTE 1:** Where a Licensed Pilot is specified, it may be substituted for an Agricultural Pilot provided there is a holder of a Heavy Vehicle Pilot Licence in the lead Overseas Agricultural Vehicle, overseeing the pilots.

**NOTE 2:** If your Overseas Agricultural Vehicle consists of an auger or conveyor with a rear overhang exceeding 10.0m, it must be accompanied by at least one (1) Agricultural Pilot to safely facilitate the excessive tail swing.

**NOTE 3:** A maximum of 3 agricultural combinations, each with up to 3 towed agricultural implements, may travel in convoy when required to be accompanied by a pilot.



# Reusing & Recycling Resources



The Beverley CRC is supporting the STEAM program run by the Beverley District High School by collecting specific items that can be repurposed by the students.

## Items that are being collected are:



Cardboard tubing - NO toilet rolls



Old mobile phones



Craft paper



Unused craft supplies - beads, buttons, string, decorative pieces



Ice cream / Margarine containers (cleaned)



Unused fabric or wool - minimum 5cm x 5cm for fabric scraps



Dead batteries - maximum size of D  
No car batteries



Plastic bottle tops (cleaned)



Dead pens, markers, textas, highlighters

**Donations taken during business hours at the Beverley CRC**

**Reduce. Reuse. Recycle.**



# SHAZMAC PLUMBING

**PROUD TO BE YOUR LOCAL PLUMBER**

Plumbing Licence: PL 5829 Gas Fitter Licence: GF 7422 RHL: L100443  
ABN: 18 531 685 326

For all your plumbing & gas fitting needs

**Phone 0408 189 987**

**PO BOX 116**

**BEVERLEY WA 6304**

**shazmac1@westnet.com.au**

**NO job is too big or too small.**



**Saturday 05 June 2021**

RAISING MONEY 2021 FOR BEVERLEY  
JUNIOR SPORTS

## BEVERLEY COMMUNITY MARKETS

Stalls, sausage sizzles, raffles



Held on the first Saturday of  
each month between March  
and December  
**STARTS 8AM**



## BEVERLEY LANDFILL SITE OPENING HOURS

Saturday  
8.00am – 4.00pm

Sunday  
8.00am – 4.00pm

Monday  
8.00am – 3.30pm

**PLEASE NOTE:  
MONDAY'S EARLIER  
CLOSING TIME**

**CLOSED Christmas Day  
and Total Harvest Ban Days**



**Old charm country pub  
Accommodation and free camping  
Air con and character dining rooms  
VISIT FOR THE EXPERIENCE  
OPENING TIMES:  
Everyday Dinner from 5.00pm  
Wednesday—Sunday from 12.00pm  
for lunch and dinner**

PH: 9641 4095

444 GREENHILLS ROAD, GREENHILLS

## Card Games at CWA

### **SAMBA**

**WHEN: Saturdays**

**TIME: 1.00pm**

**WHERE: CWA Hall**

Afternoon Tea provided.

Phone 9646 1271

### **BRIDGE**

**WHEN: Monday's**

**WHERE: CWA Hall**

**Brick & Mortar RESTORATION**  
A FAMILY TRADITION SINCE 1945

**WHY CHOOSE US**

- ✓ Family Tradition Since 1945
- ✓ We are committed to deliver the best possible Customer Service experience for our Customers
- ✓ No pushy salesman on commission
- ✓ Our Team are direct Employees of Brick and Mortar Restoration
- ✓ We train Apprentices in Heritage Brick Restoration
- ✓ No External Call Centres
- ✓ The Owners of the Business Ross & Tammy Femihough are always available
- ✓ State Distributor of Thorhelical products
- ✓ Approved Installers for Thorhelical Remedial Solutions
- ✓ Employmore Workplace Confidence Member
- ✓ Workers Compensation Insurance
- ✓ Product and Public Liability Insurance \$20 Million
- ✓ State Distributor of Round Tower Hydraulic Natural Lime

*Over 60 years of experience in the Building Industry, Restoration Industry, Insurance Builders and Brick Repairs Industry*

**Tuckpointing | Mortar Pointing  
Stonemasonry | Crack Repairs  
Brick Restoration  
Limestone Restoration  
Rendering | Ceiling Repairs  
Pebble Dash Render  
Stucco Render  
Lintel Replacements  
Wall Alterations | Carpentry  
Plastering | Paint Removal  
Lath and Plaster**

Call 1800MORTAR (667827)    [www.brickandmortarrestoration.com.au](http://www.brickandmortarrestoration.com.au)    [info@brickmortar.com.au](mailto:info@brickmortar.com.au)

Take the opportunity to join in gentle activity aimed at general fitness and falls prevention.

## Stay Active with the Beverley Everlastings

Stay Active is a weekly one-hour keep fit session for those who find gentle aerobic, strength, balance and stretching exercise beneficial to their health.

The exercises are designed for over 50s, but younger participants are welcome. Those less mobile or those recovering from accident and illness also find the exercises useful.

Chair exercises are available and participants can opt to do all or some of these.

Stay Active

**Date: Tuesday's**

Time: 9:00am

Place: Beverley Recreation Centre

Cost: \$1

Come along for social-distancing fun activity.

Stay Active is a volunteer community health program coordinated by the Wheatbelt Health Service



Government of Western Australia  
Department of Health

# C & B TRANSPORT

DELIVERING GENERAL FREIGHT AND CHILLER GOODS

3 DAYS PER WEEK OR AS REQUIRED

TO

**BEVERLEY, BROOKTON, PINGELLY**

FROM

**PERTH DEPOT CANNINGVALE MARKETS**

PLEASE CONTACT PAUL BALDWIN

ON

**0417 953 968 or 08 9646 0461**

**BIG ENOUGH TO DO THE JOB SMALL ENOUGH TO CARE**

# RA-AN ENTERPRISES

EARTHMOVING CONTRACTOR

Dam sinking  
Dam cleaning & enlargements  
Fence Lines  
Shed sites etc.



Dozer & Excavator Hire  
Dozer with Rake  
Can provide Bobcat - Backhoe - Grader - Side Tipper  
For larger jobs 54 tonne Dozer

**Contact: Ray 0428 936 621**

## CWA York great advocates!



The ladies at CWA York continue to be busy advocating for our Wheatbelt community and beyond. Accordingly, we invited Di Holland and Jacey Brown (photo on left) from Share and Care Community Services in Northam to our Branch meeting in May 2021 to talk to us about the domestic violence crisis in our society.

Also in relation to advocacy, some of our members (picture below on left) participated in the Associated Country Women of the World (ACWW) walk around York. Like CWA throughout Australia, ACWW's focus is to "amplify the voices of rural women". The walk highlighted the importance of supporting women all over the globe to have better access to water.

Sadly, we all seem to be affected in some way by the prevalence of cancer so some of the ladies (picture below on right) headed off to Toodyay recently for the Cancer Morning Tea.

Our organisation is also about service, education and friendship. CWA York continues to grow in number; at last count there are now 39 of us. It is always exciting to welcome new people into the fold and rewarding to get to know them too.



ANIMAL HEALTH, CHEMICALS, FENCING, FERTILISER, PET FOOD, SEED, STOCK FEED, WATER EQUIPMENT



**AVON VALLEY AG**  
LONG LIVE LOCAL

LOT 502 DE LISLE STREET, BEVERLEY  
TRADING HOURS MON-FRI 8AM-5PM

CHLOE FLEAY 0400 921 520  
BARRY FRASER 0427 940 827



*Locals Supporting Locals*

# LEH



## EARTHMOVING

LOCAL BUSINESS, SERVICING BEVERLEY FOR OVER 10 YEARS

## Beverley Earthmoving & Grading

**GRADER - BACKHOE - BOBCAT  
TIP TRUCK - EXCAVATOR  
SIDE TIPPER - DOZER**

ROAD BUILDING AND MAINTENANCE

FIRE BREAKS - CONTOUR BANKS - ROADED CATCHMENTS

HOUSE PADS - SEPTIC SYSTEMS - SAND, GRAVEL AND BLUE METAL  
DAM BUILDING AND CLEANING

**CALL- DAN WILKINSON**

**0417 093 090**

**EMAIL- DAN.ZOE@BIGPOND.COM**

**WWW.FACEBOOK.COM/LITTLECOHILLEARTHMOVING/**

### **PRIMARY HEALTH SERVICES**

Available to the community of Beverley

You can refer yourself or your child to the following health professionals:

**Child Health Nurse** - 9646 3200

to make an appointment, Hospital Admin Staff will assist you in setting an appointment time, which will be on most occasions a Monday.

**School Health** – 9641 0200

**Dietetics** – 9690 1320

**Occupational Therapy** - 0429 466 224

**Physiotherapy** – a Doctors referral is required – Please send all referrals to PO Box 142 Beverley or drop them into the Beverley hospital. All referrals are forwarded onto to Northam Hospital where they are prioritised and wait listed. Clients will be acknowledged with a letter informing them of the approximate wait time and will be seen in Beverley

**Podiatry** – a Doctors referral is required Please send to PO Box 142, Beverley or drop referral to the Beverley Hospital (attendance Fridays) \*\*

**Social Work** – Phone 9690 1320

**Speech Pathology** – Phone 9690 1321

- Services are provided at the Primary Health Building, on the corner of John and Forrest Streets, Beverley. There may be a waiting time for services.
- These services are provided by WA Country Health Service and are free of charge. (Please note that the Podiatry Service is a private practice and is not free of charge - there is a fee at first consultation but the WACHS/Beverley Health Service do not get involved in taking fee payments – only assisting at receiving the referrals for appointment. The Doctor's referrals are usually faxed to the service provider, Como Podiatry, who contact the patient by phone and make an appointment).
- If you have any concerns about your own health or your child's health and development, please phone the relevant health professional to discuss your concerns. Alternatively, you can speak to the Child Health or School Health Nurse, or your GP, to discuss your concerns and to determine the most appropriate referral.

*Avon & Central Primary Health  
Promoting Healthy Lifestyles*



WESTLANDS & BUSY  
BUSH BEES

## LOCAL HONEY

Available at the Beverley  
Visitor Centre



# BEVERLEY MEDICAL PRACTICE



Providing excellent quality health care to the community of Beverley and the surrounding areas

Located at the corner of John and Forrest streets (diagonally opposite the Beverley Hospital)

"Cullen House" 106 Forrest Street, PO Box 434 Beverley WA 6304

Phone: 08 9646 1241 Fax: 08 9646 1049

Email: [beverleymedical@westnet.com.au](mailto:beverleymedical@westnet.com.au)

The Beverley Medical Practice Bulk Bills patients with a current Medicare card

## BEVERLEY OPENING HOURS

Monday to Friday

9am to 1pm & 2pm to 5pm

(Closed Sundays and Public holidays)

The Beverley Medical Practice is an AGPAL accredited practice and therefore is compliant with the RACGP 5<sup>th</sup> edition standards of General Practice

### General Practitioners

Dr. Remi Adebayo,

Dr. Olay Omoniyi,

Dr. Sola Oyetunji

### Practice Nurses

Lynley, Savneet and Wendy

Monday to Friday 9am – 4pm

BP checks, woman's health, pap smears, spirometry, vaccinations, counselling, My Health, Drivers and Health Assessments, wound care etc.

### Your friendly practice team

Manager – Dawn

Receptionist – Kris, Mary & Emily

### Allied Health Services

Diabetes Educator, Dietician, Hearing clinic, Physio, Podiatry, Chiro, Counselling

### *Brookton Medical Practice*

*Now open 5 days a week - Monday to Friday*

**Saddleback Medical Centre**

27 Whittington Street, Brookton 6306

**Phone: 08 9642 1485**

## Practice News - Influenza vaccines are here!!!

### Who should get a flu vaccine?

Vaccination experts recommend flu vaccination for all people aged 6 months and over.

### Who is eligible for a free flu vaccine?

Under the National Immunisation Program, free flu vaccines are provided to the following groups who are at higher risk of complications from flu:

- children aged 6 months to less than 5 years
- all Aboriginal and Torres Strait Islander people aged 6 months and over
- people aged 6 months and over with certain medical conditions that increase their chance of severe influenza and its complications
- pregnant women (at any stage during pregnancy)
- people aged 65 years and over.

### **We are your COVID 19 Vaccine Provider- taking appointments for patients who fit the following criteria:**

- Elderly people aged 70 and over.
- People over 50 years of age
- Aboriginal and Torres Strait Islander people aged 55 years and over.
- Adults with an underlying medical condition or significant disability.

**Please contact us for appointments and any further information on 9646 1241.**

Care outside normal opening hours - When the Beverley Medical Practice is closed you can always get medical attention by calling-Ready Care **1800 225 523** or Calling health direct 1800 222 222 or by attending the Beverley District Hospital, located in Sewell Street Beverley were experienced staff will triage the patient and contact the on-call.

**For all Emergencies call 000**



## The European wasp wipe out!

After successive, challenging seasons, WA can breathe a sigh of relief and celebrate some spectacular results.



**Photo caption:** Insecticide treatment of underground European wasp nest

The 2020-21 European wasp (*Vespula germanica*) surveillance season has finished strongly with nest numbers plummeting to the lowest they've been in 12 years and not a whisper from the destructive pest for months!

This victory comes after three years of sustained efforts: additional resourcing, strong community reporting, multi-government departmental collaboration, and a WA-first baiting program implemented across 2,530 hectares (25.3km<sup>2</sup>) of rugged bushland in the Perth Hills. It took everything from the playbook and a few new innovative moves to detect, delineate and wipe out this pest.

### Season stats:

- 68,100 ha (68.1km<sup>2</sup>) under intensive surveillance
- 3,000+ surveillance traps deployed
- 14 nests destroyed – all in the Perth metro
- 4 confirmed public detections
- ALL hot spots ERADICATED!

### An enviable history

European wasps have hitchhiked their way around the globe, establishing and spreading everywhere within their biological range, largely unchallenged... except in WA. Since 1977 when first evidence of this pest emerged in WA, we've mounted an attack.

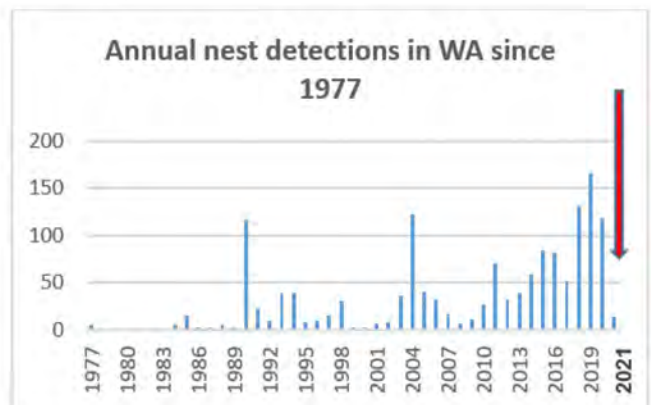

European wasps have permanently established in south-east Australia (SA, NSW, ACT, VIC and TAS) but are not subject to state-wide control programs, resulting in an annual influx of wasps into WA.

So, we must not let our guard down, as **detections must be made early** to have the best chance of eradication and prevent the permanent establishment and spread of this pest. Brush up on your European wasp identification skills, consider trapping alongside us and learn more about this surveillance program at [agric.wa.gov.au/wasps](http://agric.wa.gov.au/wasps) or contact our Pest and Disease Information Service. Until next season!

## Report suspect pests



MyPestGuide™ Reporter  
via app or online  
[mypestguide.agric.wa.gov.au](http://mypestguide.agric.wa.gov.au)



Pest and Disease Information Service  
(08) 9368 3080  
[padis@dpird.wa.gov.au](mailto:padis@dpird.wa.gov.au)





Go the distance.

No matter how far  
your doctor is.

No excuses

See your doctor if you  
notice anything different  
with your body.



For more information visit  
[www.findcancerearly.com.au](http://www.findcancerearly.com.au)

BEVERLEY EARLY YEARS GROUP PRESENTS

Storytime

Toy Library



2021 DATES

- 17th February
- 24th March
- 21st April
- 19th May\*
- 23rd June
- 21st July
- 11th August
- 15th September
- 20th October
- 10th November
- 1st December

\* National Simultaneous  
Storytime - Venue & Time TBC

FREE!

ONCE A  
MONTH ON  
WEDNESDAYS  
@ 9-30

VENUE: TOWN  
LIBRARY @  
CORNERSTONE



FEATURING:  
STORIES, SONGS, FUN!  
AN INTERACTIVE 30  
MINUTE SESSION FOR  
BEVERLEY KIDS

*All Welcome!*

For more information, contact Kelly on 0428 779 234

AVON GLAZING

Everything Glass...

Windows Splash Backs  
Mirrors & More

Ron Robinson  
0427 185 291

BEVERLEY  
Transport

Your local carrier for over 30 years.

GRAIN, FERTILISER, LIME, HAY,  
WOOL AND SIDE TIPPERS AVAILABLE

Garry & Sarah Miller

0428 464 066

admin@beverleytransport.com.au

# Painter Decorators

All repairs & painting

Lyndon & Cameron Grover

0427 661 302

lydongrover@bigpond.com

Reg: 3941



- Plastering
- Pressure Cleaning Roof
- Gyprock
- Spray Painting
- Repairs
- Gutter Replacing

NEED PRACTICAL TRADE ASSISTANCE?

## D & M Services

(Design and Manufacturing Services)

Solving a range of practical needs and problems..

Specialising in:

- ✓ Kitchen renovations
- ✓ Shop fitting and modifications
- ✓ Furniture restoration
- ✓ General carpentry
- ✓ Alterations & installations
- ✓ Metal based fabrication
- ✓ Motorhome and Caravan fitouts
- ✓ Pergolas, Decks & Gazebos
- ✓ Designing and planning

Guy Slingerland

0403602335

*Beverley Community Markets and OP Shop open on the first Saturday of the month.*

# Dawson's Concrete & Reinforcing

"Your Local Beverley Concreter"

- Concrete Formwork & Steel Fixing
- Driveways, Shed floors, Maintenance pits, Silo pads, Super sheds, House pads
- Fully mobile service
- Over 30 Years Experience
- 7 Days A Week
- Professional, Reliable Service

*Phone for a Free Quote*

**SANDY DAWSON**

**Mobile: 0417 375 221**

Email: [pameladawson@bigpond.com](mailto:pameladawson@bigpond.com)

FB: [www.facebook.com/dawsonconcrete](http://www.facebook.com/dawsonconcrete)

Beverley CRC presents

# Marketing Your Business Online

GOAL  
 PLAN  
 ACTION

- SET \$\$ GOALS
- DESIGN A MARKETING PLAN
- IMPLEMENT A MARKETING STRATEGY
- STAY FOCUSED
- HIT YOUR TARGET

17 June 2021  
10.30am - 2.30pm

BOOK NOW ON 9646 1600

\$50 per person includes lunch



TA5515854

**Phoenix Building Systems**  
*Global Specialists in Modular Steel Buildings*

- WA owned family business
- Registered Builder
- Servicing regional WA
- On Site - Expert Advice

**NEED EXTRA MACHINERY, HAY, GRAIN OR FERTILISER STORAGE?**

- Council Approvals
- Concrete, Water & Solar Options

**0427 424 672**

admin@phoenixbuildingsystems.com.au



**www.phoenixsheds.com.au**  
**/drive-through-sheds**

**KARRADALE LIVESTOCK TRANSPORT**  
**YORK LIVESTOCK TRANSPORT**  
ABN 64 054 007 721

We service Beverley, Brookton, York & surrounding districts

Available to transport Sheep & Cattle

No job too big or small

Support the local communities

Member of ALRTA

If you need stock moved, Peter would love to hear from you - 0428 481 281





**Beverley Agricultural Society (Inc)**

PO Box 108 Beverley WA 6304

[beverleyagsociety@gmail.com](mailto:beverleyagsociety@gmail.com)

## Membership Form 2021

**Standard Membership \$25 two (2) adult tickets**

**OR**

**Family Membership \$30 – two (2) adults and three (3) children (immediate family, 4-15 years)**

**Additional children \$3**

Please fill out the contact details clearly so we can keep our database up to date.

Name \_\_\_\_\_

Address \_\_\_\_\_

Phone no \_\_\_\_\_

Email address \_\_\_\_\_

### Membership Type – please tick

Standard (two adult tickets)

Please list names for tickets \_\_\_\_\_ (member)

\_\_\_\_\_ (guest)

Family (two adult tickets plus up to three children 4-15 years)

Please list names for tickets \_\_\_\_\_ (member)

\_\_\_\_\_ (guest)

\_\_\_\_\_ (child 1)

\_\_\_\_\_ (child 2)

\_\_\_\_\_ (child 3)

Additional children

\_\_\_\_\_ (child 4)

\_\_\_\_\_ (child 5)

### Method of payment

EFT (preferred)

BSB – 016-540

Account – 2599 03452

Please include your name in the reference field

\*Remember to post or email form to above address.

Cheque

Payable to Beverley Agricultural Society

PO Box 108 Beverley WA 6304

**Schedules will be available for download from our website or to collect from local businesses.**

[www.beverleyagsociety.com](http://www.beverleyagsociety.com)

Be very country

Saturday 21  
August 2021



# BEVERLEY SHOW

Proudly sponsored by **BEVERLEY HYDRABOOM H. RUSHTON & CO.**   
*Sticking together for 20 years!*



**Entertainment**  
Free Kids Entertainment  
Big Rides, Climbing Wall  
Old MacDonalds Farm  
Dog High Jump Demo  
Coastal Scottish Pipe Band  
Stalls, Side Show Alley  
Agricultural Displays  
Farm Machinery  
Car Displays  
Equestrian Jumping  
Cattle Judging  
Sheep, Poultry, Crafts and Wool  
Sundowner: Fireworks, Music and Bar

Join the ag society, memberships go to [beverleyagsociety.com](http://beverleyagsociety.com)

Beverley Town Oval, Forrest Street

Gates open at 9am til late

Admission

Adults \$13

Pensioners/Carers \$6

Children under 16 \$6

Children under 4 free entry

Proudly supported by



HOLLIE SMITH  
PHOTOGRAPHY



# FRIDAY BINGO!

FRIDAY 25 JUNE 2021

BEVERLEY  
CORNERSTONE  
141 VINCENT ST



EYES DOWN 1.00PM  
FINISHING AT 3.00PM

AFTERNOON TEA AVAILABLE  
FOR MORE INFORMATION  
CONTACT SAM 9646 1600



  
northam optical



- Bulk billing to Medicare
- HBF & DVA Provider
- Competitive prices
- Great range of frames & sunglasses
- Locally owned and operated

[www.northamoptical.com.au](http://www.northamoptical.com.au)

138 Fitzgerald St Northam WA P 9621 1131  
E [northam.optical@yahoo.com.au](mailto:northam.optical@yahoo.com.au)

## Now Open



BEVERLEY  
PHYSIOTHERAPY

**Kahlia Ferguson  
Physiotherapist**

Every Thursday in Beverley Chiropractor Centre  
in the Cornerstone Building  
(Entrance off Dawson Street)

Sports injuries, osteoarthritis, muscle strains,  
neck pain, back pain, headaches,  
post-op management

Enquiries and Bookings:

Phone 0437 709 577

Book Online at [www.beverleyphysio.com.au](http://www.beverleyphysio.com.au)

BEVERLEY GOLF CLUB



04, 05 & 06 AUGUST

Avon Valley

LADIES GOLF CHAMPIONSHIP  
2021

THANKS TO THE FOLLOWING BUSINESSES  
AND INDIVIDUALS WHO HAVE BEEN  
GENEROUS WITH THEIR SUPPORT.

SHAZMAC PLUMBING, BEVERLEY TRANSPORT  
SERVICES, DUNNINGS FUEL - NORTHAM,  
WHITFERT FERTILISERS, FUEL DISTRIBUTORS  
YORK, HON. MIA DAVIES, CHRISTIAN PORTER MP,  
AGLIME OF AUSTRALIA, BEVERLEY GAS &  
PLUMBING, PURSLOWE & TINETTI FUNERALS,  
JOHN ISLIP, WEST COAST WOOLS - YORK,  
WFI - BEVERLEY, LOOSE STITCHES - QUAIRADING  
AND CAPE VILLAS - DUNSBROUGH

## York Chiropractic

MacLachlan Centre – 4 Trews Road



Clinic available every week

9641 1500

Dr Alexandra (Sacha) Browne

*B.Sc (Chiropractic) B.Chiropractic*



Also available in Cunderdin and Merredin

# BEVERLEY QUILTING GROUP

We meet on Tuesday's at the Masonic Lodge in the  
back room. We start at 9.30am and finish at 2.00pm

\$2 donation per session and BYO lunch.

For further information contact Jan Sherwood on

0438 019 510

## TAX RETURNS

### FORTIZ BUSINESS SOLUTIONS

(Registered Tax Agent & Certified Public Accountant)

Tax Returns for all entities  
Business Consulting  
Software solutions / setup  
Bookkeeping / Accounting

OFFICE HOURS:

FRIDAY 9.00am – 4.30pm

101 VINCENT ST (Bankhouse) BEVERLEY

Please phone for an appointment

9646 0282

## Mulesing Contractor



For all your  
Mulesing Requirements  
Beverley, York  
and surrounding areas

Contact Terry Slade

0427 635 065

## **Cunderdin, Beverley Kellerberrin Exercise**



On Saturday 08 May some of our local volunteers participated in a training exercise at Cunderdin.

The exercise was a mock motor vehicle accident involving 2 cars where St John Volunteers, along with Fire & Emergency Services used their skills to treat four patients. The passengers in one of the vehicles were trapped and had to be cut out. The crews dealt with spinal injuries, critical care and general well-being of the patients.

The joint operation involved crew from Cunderdin, Kellerberrin and Beverley with the Fire and Emergency Services volunteers coming from Cunderdin and Quairading.

The exercise was organized by our Clinical Paramedic Drew Richardson, Kirra Ten Hove-Smith - Regional Training & Development Coordinator - and Cunderdin Sub Centre.



The volunteers from Beverley who participated found this exercise informative, as well as a valuable opportunity to work in conjunction with Fire and Emergency services.



### **Training**

As well as the training exercise at Cunderdin, our volunteers have invited the Cunderdin volunteers to Beverley to join us for our training nights.

These nights have been well attended and we have enjoyed the opportunity to share our knowledge and skills with each other.



### **Congratulations Keith Hawkins**

As one of our newer volunteers, the sub centre congratulates Keith Hawkins. As with all Ambulance Officers, Keith began as an Emergency Medical Responder. In recent weeks, Keith has completed further training and has moved up in level to become an Emergency Medical Assistant.

Congratulations Keith!!



### **ANZAC Day**

Once again, the Beverley sub centre was represented at the Anzac Day service.

Unfortunately, due to COVID on the Anzac Day weekend, some of our Volunteers were unable to march this year. However our available sub centre volunteers laid a wreath to commemorate those who paid the supreme sacrifice.



## First Aid Course

Beverley Sub Centre recently held a first aid course. With the sub centre providing morning tea, light lunch and afternoon tea the course attendance was very pleasing. We hope to hold another course in June, so if you missed out and are keen to update your First Aid knowledge by completing HLTAID011 Provide first aid, we will advertise in the near future.

## Volunteers

We welcome people that are keen to become Volunteer Ambulance Officers or just to be involved in the local Sub Centre. Please contact Christine (0417 969 993) if you wish to have a chat about how you can become involved.



## Lifestyle Solutions

### Become A Foster Carer

Being a Foster Carer gives you a great opportunity to make a difference to the life of a child. Like the children we place, our Foster Carers come from a range of backgrounds.

We are seeking Foster Carers in the Wheatbelt Region of WA.

To find out more about becoming a Foster Carer call one of our friendly staff on 1800 634 748, email us at [enquiry@lifestylesolutions.org.au](mailto:enquiry@lifestylesolutions.org.au) , or find us online:

[lifestylesolutions.org.au](http://lifestylesolutions.org.au)

[facebook.com/lifestylesolutions](https://facebook.com/lifestylesolutions)

[twitter.com/lifestylesolns](https://twitter.com/lifestylesolns)



# Mia DAVIES MLA

Leader of The Nationals WA

**CENTRAL WHEATBELT**



**Northam Office**  
 171 Fitzgerald Street  
 (PO Box 92)  
 Northam WA 6401  
 Ph 08 9622 2871  
 Fax 08 9622 1668

**Merradin Office**  
 The Old Town Hall, Mitchell St  
 Merradin WA 6415  
 Ph 08 9041 1702  
 Fax 08 9041 2554  
 Freecall 1800 673 914

[mia.davies@mp.wa.gov.au](mailto:mia.davies@mp.wa.gov.au)  
[www.miadavies.com.au](http://www.miadavies.com.au)  
 MiaDaviesMLA  
[facebook.com/MiaDaviesMLA](https://facebook.com/MiaDaviesMLA)

**THE NATIONALS** for Regional WA

Authorised by M.Davies, Northam Boulevard Shopping Centre, Fitzgerald Street, Northam.

# Countryside Memorials

Cast Stone  
 Granite  
 Marble  
 Plaques

Added Inscriptions  
 All Repairs and Restorations



**25 YEARS PROFESSIONAL EXPERIENCE**  
**FREE DESIGN AND QUOTE**

**Servicing All W.A. Country Areas**

**9696 0466**

**OXTER SERVICES**

[www.oxter.com.au](http://www.oxter.com.au)

[oxter@westnet.com.au](mailto:oxter@westnet.com.au)

Anglican Parish of Beverley/Brookton

Times of Services for:

**JUNE 2021**

DAY	CHURCH LOCATION	TIME	SERVICE
Sunday 6 <sup>th</sup> June	St. Mary's Beverley	9.00am	Prayer and Praise
Sunday, 6 <sup>th</sup> June	St. John in the Wilderness West Dale	9.00am	Morning Prayer
Sunday, 6 <sup>th</sup> June	St. Mark's Brookton	8.30am	Prayer and Praise
Sunday, 13 <sup>th</sup> June	St. Mary's Beverley	9.00am	Prayer and Praise
Sunday, 13 <sup>th</sup> June	St. Mark's Brookton	8.30am	Morning Prayer
Sunday, 20 <sup>th</sup> June	St. Mary's Beverley	9.00am	Morning Prayer
Sunday, 20 <sup>th</sup> June	St. Mark's Brookton	8.30am	Prayer and Praise
Sunday, 27 <sup>th</sup> June	St. Mary's Beverley	10.30am	Morning Prayer Combined Service <b>AGM to follow</b>
Sunday, 4 <sup>th</sup> July	St. Mark's Brookton	8.30am	Prayer and Praise
Sunday, 4 <sup>th</sup> July	St Mary's Beverley	9.00am	Prayer and Praise
Sunday, 4 <sup>th</sup> July	St. John in the Wilderness	9.00am	Morning Prayer

Telephone contacts : Beverley - 0484 849 159 or 0419 194 420

Brookton - 9642 1373 or 9642 2357

All mail including St. Mary's Society please address to PO Box 293, Beverley 6304

Please go to our web site for more details

[www.beverleybrooktonanglicanparish.org](http://www.beverleybrooktonanglicanparish.org)

**BEVERLEY  
REAL LIFE  
CHURCH**



*Living life with  
Christ*

*All Welcome  
Every Sunday  
10 am*

**50 Hunt Road, Beverley**



**CATHOLIC CHURCH**

Service in Beverley  
8:00am every Sunday at  
Beverley Sacred Heart Church  
Lukin Street, Beverley

SAVE THE DATE

*Spring Back to  
Beverley*

SEPTEMBER 2022

Celebrating 150th Anniversary of Beverley Road Board, 150th  
Anniversary of Dead Finish Museum &  
other significant Shire of Beverley projects

Watch this space for more information.....



**THE RELIGIOUS  
SOCIETY OF FRIENDS  
(QUAKERS)**

Beverley Friends Meeting  
Old Catholic School Rooms  
Dempster Street

Meeting for Worship  
SUNDAY at 10:30am

For more information & enquiries  
phone 0408 090 345

## Passions and Interests vs Self-Sabotage

Our interests and passions are an integral part of our ongoing health. They underpin an often-neglected part of our holistic wellbeing and health, known as “*social-spiritual wellbeing*”. As blokes we need to constantly challenge ourselves to experience more and engage with new opportunities. There is more to us than just our occupations and we need to explore the things that excite and interest us. These passions and interests, the things that make us tick, are where we as blokes get a sense of purpose and identity. Often however, our hardwired competitive nature, and need to win can sabotage us.

A few years ago, at age 40, I pulled on the boots to play my first ever season of AFL footy. I wanted to be involved as my eldest son was playing and I had visions of playing out the season in reserves and having some great father/son bonding time. As it turned out, he went straight into the league team after only two reserves games and I played for a couple of seasons, having a ball with a great bunch of blokes.

Sometimes, mates with outstanding footy pedigrees would say to me “*How do you do it?*” and honestly, I couldn’t understand their question. I was slow, lacking in skills and pretty unfit, but I was having fun, and getting a little bit fitter. I loved it! I only understood their plight a couple of years later when I got back into a form of motorsport that I had been reasonably competitive at in my 20’s, rallying.

I was keen as mustard to get back into rallying after a 10-year hiatus, but as I progressed through the season, I realised I wasn’t really enjoying it. I wasn’t committing to the pace-notes; I wasn’t holding it flat over the crest that my notes said I could. I knew how hard I needed to push, but the middle age me couldn’t get to where the 20-year-old me had set the bar. It was getting me down, and as I drove into the midway service park (the pits) at my last event I knew it was time to finish up when I was wishing the event was over. The younger me used to wish that the rally would just keep going, there never seemed to be enough competitive k’s.

My mate’s question about “*how could I possibly enjoy footy in my 40’s?*” suddenly became clear. I didn’t have a younger footy-self against which to measure; my next game could still have been my best even if that best wasn’t very good at all. My feelings about rallying suddenly made his feelings about footy so much clearer.

This serves as an illustration that our competitive natures can sometimes get in the way of us engaging with a new passion or interest. It might take moving out of our comfort zone to a new hobby or past-time to give us the space we need so that we are not constantly measuring ourselves against our old markers of competence or manhood.

*For more men’s health and wellbeing information check out our website, here you will also find our Working with Warriors podcast series. Alternatively get in touch with us via the details below for a chat about arranging one of our community educators to present a health and wellbeing session or run a Fast Track Pit Stop for your local community group or club free of charge.*

Glen and the Team

The Regional Men’s Health Initiative  
delivered by Wheatbelt Men’s Health (Inc.)  
PO Box 768, Northam WA 6401  
Phone: 08 9690 2277  
Email: [menshealth@4blokes.com.au](mailto:menshealth@4blokes.com.au)  
[www.regionalmenshealth.com.au](http://www.regionalmenshealth.com.au)



 **VALLEY FORD** 

• NEW & USED VEHICLES •  
• SERVICE & PARTS •

**9622 5588**

[www.valleyfordnortham.com.au](http://www.valleyfordnortham.com.au)

Cnr Peel Tce & Fitzgerald St, Northam

 **NORTHAM HYUNDAI** 

SALES ★ SERVICE ★ PARTS

**9622 5588**

[www.northamhyundai.com.au](http://www.northamhyundai.com.au)

37 Fitzgerald Street, Northam

# GAME ON CONTRACTING



Servicing Beverley & Surrounding Areas  
Local Owner Driver David Johnson  
PH: 0428 995 950  
Email : [Gameoncontracting@gmail.com](mailto:Gameoncontracting@gmail.com)

For all your Transport needs:  
Side-tippers, Endtippers, Float  
Liquid Fertilizers, Drop Decks &  
Semi water cart for roadworks.

For your Earthwork needs:  
20 tonne Excavator, Grader &  
Loader with Accredited Load Rite System



## BEVERLEY REDBACKS HOCKEY CLUB

With the 2021 hockey season kicking off on the first weekend of May the Redback ladies are gearing up for another season of fun on the field. Training is in full swing 6pm Thursdays under the watchful eye of our fantastic new coach Norm Veitch.

### Contact Details

Secretary: Britt Hadlow  
M: 0447 811 267

E: [beverleyhockey@live.com.au](mailto:beverleyhockey@live.com.au)

Facebook:  
Beverley Redbacks  
Hockey Club

Instagram  
[beverley.redbacks.hockey.club](https://www.instagram.com/beverley.redbacks.hockey.club)



Phone 9646 1347  
104 Vincent Street  
Beverley WA 6304  
Geena 0448 281 158  
Steve 0448 281 044

[freemasonstavernbeverley@westnet.com.au](mailto:freemasonstavernbeverley@westnet.com.au)

*Weekdays*

**MONDAY - FRIDAY  
EVENING MEALS**

**OPEN FROM 4.00PM  
6.00PM - 8.30PM**

*Weekends*

**SATURDAY & SUNDAY  
LUNCH  
EVENING MEALS**

**OPEN FROM 11.00AM  
12.00PM TILL 2.00PM  
6.00PM TILL 8.30PM**

THE TRADING HOURS ARE SEASONAL. PLEASE ENQUIRE FOR FUNCTION BOOKINGS.  
Times are negotiable for bookings of 15+

## E Squire Contracting Services

Water Supply  
Windmills & Accessories  
Solar Pumps:  
Sales, Service, Installation  
Fencing & Yards  
Trenching & Poly Pipe Laying

**E Squire Contracting Services  
Beverley and surrounding districts**

**Phone: 9646 0800**

**Errol Squire 0438 682 687**

## Unique Strokes W.A. Painting & Decorating

Reg. No. 4236

ROB BAIN

QUALIFIED LOCAL TRADESMEN

For Guaranteed Traditional  
Workmanship & Prompt Free Quotes

**Phone: 08 9647 2102**

**Mobile: 0418 904 013**





# BEVERLEY FOOTBALL CLUB



## ROUND 4—Sunday 2nd May

### League Results

RAILWAYS 8.13 - 61

BEVERLEY 12.14 - 86

**Best Players:** K Ugle, J Morton, A Boyse, J Slater, T Etto

**Goal Kickers:** A Boyse 4, K Quartermaine 3, D Nelson 2, K Ugle, A Stanfield, L Henry

### Reserves Results

RAILWAYS 27.17 - 179

BEVERLEY 3.0 - 18

**Best Players:** A Smith, N Styles, T James

## ROUND 5 - Saturday 8th May

### League Results

YORK 17.8 - 110

BEVERLEY 10.12 - 72

**Best Players:** J Morton, K Ugle, M Ashworth, D Nelson, J Mann

**Goal Kickers:** K Quartermaine 3, J Adams 2, K Ugle 2, D Franklin, B Fotheringham, B O'Meagher

### Reserves Results

YORK 24.23 - 167

BEVERLEY 1.2 - 8

**Best Players:** F Ochtman, D Byron, M McLean, D Shilling

**Goal Kickers:** R Gillespie

## ROUND 6 - Saturday 15th May

### League Results

BEVERLEY 8.5 - 53

QUAIRADING 20.8 - 128

**Best Players:** J Mann, B McLean, J Morton, D Nelson

**Goal Kickers:** K Ugle 3, D Nelson 3, D Macaulay, A Boyse

### Reserves Results

BEVERLEY 2.6 - 18

QUAIRADING 16.11 - 107

**Best Players:** N Styles, D Byron, S Murray, T Wilson, M McLean

**Goal Kickers:** N Styles, J Eades

## NETBALL RESULTS

### ROUND 4

RAILWAYS 34 **Best Players:** Narelle

BEVERLEY 32 Bailey, Gemma Bassett, Ashlyn Rigeway,

### ROUND 5

YORK 26 **Best Players:** Narelle

BEVERLEY 48 Bailey, Ashlyn Rigeway

### ROUND 6

QUAIRADING 35 **Best Players:** Narelle

BEVERLEY 28 Bailey, Gemma Bassett

### Upcoming Games:

Kellerberrin vs Beverley—30th May

Federals vs Beverley—6th June

Beverley vs Kellerberrin—13th June

Beverley vs Railways—27th June

Well the season is well and truly underway in the Avon Football Association. It has been a tough start for our reserves team who are struggling for numbers each week.

League has also had a mixed bag, with a large number of injuries making this difficult for our coach. We have 2 wins on the board now and are looking forward to the coming weeks.

Our netball team has had a few close games to start the season and have one win on the board so far.

We would love to see some more supporters at our home games to cheer us on!

*See you at the footy!*





# ANNUAL GREEN WASTE & BULK WASTE KERBSIDE COLLECTION

**TUESDAY 08 JUNE 2021**

Council will provide a GREEN WASTE & BULK WASTE KERBSIDE collection for residential properties within the townsite boundary commencing on the above date.



## WE WILL REMOVE:

- \* Garden and green waste - max length 1.5m
- \* Old furniture
- \* Stoves and refrigerators (doors removed) and other white goods
- \* Car parts – only if they are drained of all fluids
- \* General household items, max length 1.5m
- \* Metal, wire, etc.

**NOTE: GROUP SIMILAR ITEMS TOGETHER**



## WE WILL NOT REMOVE

- \* **Building Materials:**  
*Such as: bricks, rubble, sand, etc*
- \* **Asbestos and cement products**
- \* **Renovation and demolition waste**
- \* **Tyres, batteries**
- \* **Foodstuffs**
- \* **Hazardous Chemicals, paint, etc**
- \* **Metal or plastic chemical drums**

### CAR BODIES AND WATER TANKS

Removal of car bodies and/or Water Tanks is **by appointment only**, please phone the Shire on 9646 1200

### PLEASE FOLLOW THESE STEPS TO MAKE COLLECTION EASIER:

1. Place bulk waste **NEATLY** on the street verge.
2. Similar waste to be grouped **SEPARATELY**, e.g. Green Waste, Furniture/timber for recycling purposes.
3. Do **Not** obstruct footpath.
4. **REMOVE** fridge doors and **DRAIN** oil from machinery parts.
5. Please **DO NOT** place your bulk waste out **BEFORE THURSDAY 03 JUNE**. This constitutes littering and is liable to incur a penalty.
6. Any items **NOT REMOVED** from your verge, **PLEASE REMOVE** or a penalty may be incurred.

# BEVERLEY NETBALL CLUB

Our Northam team have started the 2021 season, already having played 4 games. Our first game was due to be played at 3:30pm but due to the Covid-19 protocols it was pushed back to 4:30pm with 12 minute quarters to fit everyone on the outside courts. Welcome to the club Jamelia Ugle and Charlize Anderson. Cheers for filling in Courtney Venning and it was exciting to see Amanda Farr back on the netball court who also filled in. The girls also came away with the win, 31-18 well done.

The second game was a little different. When it became evident that there were no umpires turning up, someone was grabbed from the sidelines to begin the game at approximately 2:10pm whilst a second umpire was soon found. From the first whistle it became clear that the game had a mixture of football and netball about it. From name calling and intentional tripping, to blatant disrespect of the umpire, we were lucky to come away with a draw, 16 all.

If you win, your a winner.  
If you lose, your a loser.  
I guess if you draw, your a drawer?

The third game almost didn't happen, but we are glad that it did. Starting the day with a player down, we were lucky Brooke Pepper answered the call and stopped talk of a forfeit by giving us 7 players. A couple of players arrived right on the first whistle and 1 player arrived close to half time due to road works. Everyone worked together and backed each other and the end result was 42 to 41 to Beverley. Well done girls, super impressive stuff.

On 22 May the Northam Netball Association held its opening ceremony. Once the formalities were over it was down to business. After thoughts that Jenifer Petchell would play hockey instead of netball, she reluctantly agreed to play giving us 7 on court. We were without Hannah Morrell, so Sam Mearns stepped up to wear the 'C' centre bib for the game and proved that you can do anything if you set your mind to it. During third quarter Jen wanted a break so when her opponent trod on her foot and an audible crack was heard, play was stopped to carry her off the court, and an ambulance was called for her opponent. But in the end the result was Beverley 35-19. Well done girls.

With an excellent start to the season, the ladder has Beverley and Renegades on top.

Our mid week Fast 5 season has also commenced as of Wednesday 19 May, with four teams from Beverley and Brookton competing. The four teams are: Beverley Green, Beverley Orange, Brookton Blue and Brookton Purple. If you want to come down to the courts on Wednesday evenings, we welcome spectators.

**Located behind the Beverley Medical Practice Cullen House  
106 Forrest Street Beverley.**



**Open 8.00am - 1.00pm  
Monday, Wednesday & Friday**

**All enquiries to Phlebotomist - Sue Ph: 9646 0724  
Please note that Western Diagnostic Pathology will accept all pathology collection forms.**



BEVERLEY HORSE & PONY CLUB INC



**PRESENTS**

**OPEN GYMKHANA FUN DAY**

*INCORPORATING HACKING  
SHOW JUMPING AND GAMES*

PLAITING OPTIONAL.  
PC UNIFORM OR HACKING JACKETS ACCEPTED FOR ALL RIDERS

**19 JUNE 2021**

BEVERLEY HORSE & PONY CLUB GROUNDS  
(ENTRY OFF FORREST ST. GROUNDS ON FAR SIDE OF OVAL)

**CANTEEN AVAILABLE**

ALL ENQUIRIES TO JESSAMIN 0447 722 958 OR  
BEVHPC.EVENTS@GMAIL.COM

ENTRY PACK ON FACEBOOK AND CAVALLETTI  
BEVERLEY (WEST AUST) HORSE AND PONY CLUB EVENTS  
AND [HTTPS://WWW.CAVALLETTI.COM.AU/EVENT/](https://www.cavalletti.com.au/event/)

*THIS IS A NON PCWA EVENT  
YOU DO NOT NEED INSURANCE TO ATTEND*

*We look forward to seeing you there!*





## BEVERLEY JUNIOR SPORTS

### BEVERLEY

Our winter season has commenced, with the first games for both netball and football, being played in Quairading on Saturday 15 May. Travelling and playing in different towns is excellent experience for the kids, and they always have fun.

Thank you to parents that travelled and helped on the day, your support is always appreciated. The teams will be travelling to Kellerberrin two weeks in a row, with the Beverley Shield being played on the 06 June. The Shield is always a highlight in our season and training is important in the lead up to this day, training remains on Wednesday afternoons.

The junior sport fixtures for June are below.  
Saturday 05 June Beverley Shield in Kellerberrin

Sunday 13 June Beverley vs Keller Tammin in Beverley

The remainder of June are training and scratch matches in town, with a break for school holidays at the start of July.

# BEVERLEY DEZIGN

Renovations,  
Alterations, BBQ's,  
Brick Fences, Steps,  
Retaining Walls,  
Brick paving laid in mortar

Phone  
Michael 0407 645 001  
Barry 0417 181 724



## WANTED



### BLOWNOUT SHEARERS

Contact: Jack Dugan Phone: 0450609281  
Email: surebetss@hotmail.com

Shearing services provided, cost plus rate or cocky shearing, full crew up to five stand available, clean, tidy, professional 25 years industry experience.



## BEVERLEY AND DISTRICTS WOOL COMPANY

- Broker Independent clip marketing advice
- On farm valuation and purchase of clips and oddments crutchings; Merino and Crossbred, small and large quantities
- Same day payment
- Shearing advances

Call Mike Fairclough  
0429 635 999



SPECIALISING IN

**AGRICULTURAL & HAULAGE**

**BATTERIES, OILS & GREASE**

**ALL SIZES & BRANDS**

**TYRE REPAIRS**

ON-CALL AFTER HOURS

**0407 457 427**

**4B DAWSON ST, BEVERLEY WA 6304**



## Beverley Ladies Golf Club

Hello and welcome to the Ladies Golf Snippets. We have had an unusual hot and humid weather for our golf, but the fairways are looking green.

Before I go into golf news, our golf club is missing white lace tablecloths. We would really like them to come back home. If anyone has accidentally taken them home to wash, can you please contact someone from the golf club.

I would like to thank our hard working course committee who have swept the greens for Tuesday's golf. It is a pity that our scores do not reflect the well swept greens!!!!

Once again I would like to acknowledge Avon Valley Ladies Championship Sponsors-Aglime, Shazmac Plumbing, Beverley Transport Services, Dunnings Fuel, Whitfert Fertilisers, John Islip, Fuel Distributors York, Honourable Mia Davies, Christian Porter MP, Purslowe and Tinetti, WFI-Charmaine Willing, Beverley Gas and Plumbing, West Coast Wools-York, Cape Villas-Dunsborough (this is a 2 day raffle for a 2 day stay) and Sharon Richards of Quairading who is a part owner of a quilting shop in Quairading called Loose Stitches. Sharon has generously donated a quilt that she has made for our 3 day raffle.



We are very happy to obtain sponsors from outside of Beverley. Please support these businesses if you can.

### Coaching

Rob Farley arrived last Friday 14 May and gave golf lessons to an enthusiastic bunch of ladies, some of which are new to golf. Welcome everyone and hopefully you can make the other 3 dates.

If you would like personal coaching with Rob, he is based at Marangaroo Golf Club and from my experience it is well worth your time.

The third session will be Friday 11 June and the final session will be Friday 25 June.

Ladies coaching begins at 9.30am and finishes at 11.30am. Men's coaching commences at 11.30am and finishes at 12.30pm. All you need to bring is \$10 for each session and of course your golf sticks.

If you are in the market to buy golf gear, Rob will help you and you will get a great price.

## BEVERLEY Clay Target Club

*Nicholas Street, Beverley*

We meet one Sunday a month and anyone who would like to try clay target shooting is most welcome to come along. Gun and ammo can be supplied by us. If you are interested in becoming a new member or would like more details. Call 0413 058 943

### 2021 SHOOT DATES

DATE	EVENT
Sunday 13 June	25 DB 25 SB
Sunday 11 July	50 DB PTS
Sunday 08 August	60 MXD
Sunday 12 September	SHOOTERS CHOICE
Sunday 10 October	25 SB PTS
Sunday 14 November	50 CONT
Sunday 12 December	CAPTAINS CHOICE

All shoots start at 10.30am

## History Vincent Street



As part of the Heritage Trail component of the Vincent Street Streetscape Project, The Shire of Beverley is seeking photos or video footage of **Vincent Street** (from Hunt Road to the Bridge) from **ANY ERA!**



If you would like to share a photo and are happy to sign a general release form for us to use a copy of your photo or video then please contact Stefan 9646 1200 or email [planner@beverley.wa.gov.au](mailto:planner@beverley.wa.gov.au)

*Thank you to those who have already contributed!*

## Results

Tuesday 27 April	<p><b>Anne Szczecinski Trophy</b> 1<sup>st</sup> Silver Spoon, 1<sup>st</sup> International Bowl and 1<sup>st</sup> Putting-Stroke</p> <p>Winner: Valda Morton 78 Nett, countback from Jane Murray <b>Many thanks to Anne for donating this trophy.</b> <b>9 Hole Competition</b> - No nine hole competition today but Gerry played with Dina Barrett-Lennard.</p>
Tuesday 04 May	<p><b>Ali Lewis Trophy-</b> Due to only a few players playing golf in the rain, Ali's trophy will now be played on Tuesday 14 September. <b>9 Hole Competition-</b>No nine hole competition today due to rain.</p>
Tuesday 11 May	<p><b>Sera Minchin and Yvonne Hobbs Trophy</b> Travel Tree <b>4BBB Stableford</b> Winners- Ali Lewis and Sera Minchin 45pts Runners Up- Chantelle Meade and Jane Murray 40pts If the winners scores are good enough, Ali and Sera will be playing off on a Perth course later in the season. Well done, Ali and Sera. <b>9 Hole Competition-</b> Stableford Gerry Anderson won again with 16 points. Handicap is going down rapidly. Well done, Gerry</p>
Tuesday 18 May	<p><b>Maxine Watts Trophy</b> 2nd Silver Spoon, 2nd International Bowl 2nd Putting and Monthly Medal – <b>Stroke</b> Winner- Marg Peck 79 Nett Runner Up- Jane Murray 80 Nett, countback from Yvonne Hobbs <b>Many thanks to Maxine for donating this trophy.</b> <b>9 Hole Competition-</b> Stableford Winner-Anne Szczecinski 17 pts Well Done Marg and Anne</p>

## Fixtures

18 Holes tees off at 10.30am. Please be ready by 10.15am. 9 Holes tees off at 12noon.

Date	Competition
Tuesday 25 May	Val Hagan Trophy Par
Friday 28 May	Tammin Open Day
Tuesday 01 June	Lorna Barrett-Lennard Trophy Monthly Medal Stableford
Tuesday 08 June	Jane Murray Trophy 3 <sup>rd</sup> Silver Spoon, 3 <sup>rd</sup> International Bowl, 3 <sup>rd</sup> Putting Stroke
Friday 11 June	Cunderdin Open Day
Tuesday 15 June	Jacinta Murray Trophy Stableford
Friday 18 June	Gingin Open Day
Tuesday 22 June	Max Hunter Trophy Jubilee Fours-Stableford

Until next month, Be Very Straight  
Sera Minchin- Ladies Captain





## Beverley Golf Club

### Apology

Last month we omitted John and Helen Shier from the list of people who have generously loaned equipment to assist with course maintenance. We apologise to John and Helen whose heavy equipment proved very useful in our pre-season preparations.

### Results for May

The first qualifying round for the Club Championship was held on 01 May. Alan Hammond beat out 17 other players to take home the **Always Green Trophy** with a score of 72 Nett (86 Gross). Six players were equal runners-up with 77 Nett! They were John Donovan (93 Gross), Luke Gollan (89), Darrell Hagan (81), Steve Johnston (84), Chris Lawlor (98) and Terry Woods (92). Thanks again to **Gavin Sazanov** for his continuing support of this event.

The **Garden Gnome Trophy** was held on 08 May. In this event the fourteen players were restricted to using only three clubs for the round. Ken Bradley edged out Luke Gollan in a countback to win the day. Both players scored 34 Stableford points. Third place went to Phil Bateman with 30 points. Thank you to **Ron Bickley** for his sponsorship.

On Saturday 15 May, eighteen players in 9 teams played Canadian Foursomes to compete for the **Beverley Electrical Services Trophy**. The winning team was Darrell Hagan and Luke Gollan with Nett 71 (Gross 77). Winners of the runners-up prize were Steve Johnston and Terry Woods who carded 75¾ (84). Many thanks again to **Karl and Hollie Smith** for their on-going support.

On 22 May we had 16 players compete for the **Belhus Trophy**. The 4-Ball Better Ball Stableford event was won by the team of Brendan Minchin and Graeme Lewis who scored 41 points. Runners-up were Phil Bateman and Martin Moseley with 40 points. Thank you to **Greg Barrett-Lennard** for his support.

The last event for the month was on 29 May, the John Donovan Trophy. This was the second qualifying round for the Club Championship and results will be posted next month.

# GROW A BUMPER CROP WITHOUT BREAKING THE BANK

Your fertiliser dollar buys more at Whitfert

If you're looking for real economies of scale on farm, go with Whitfert's range of proven, quality fertilisers that don't cost the earth. Improve your yield potential without breaking the bank.

Go with Whitfert

CALL: 1800 654 089  
[www.whitfert.com.au](http://www.whitfert.com.au)



## Scroungers

These events continue on Wednesday and Friday afternoons. Due to the shorter winter days, tee-off will be at the earlier time of 3:30pm during June.

Scrounger results:

Wednesday 28 April – 16 players – won by Darrell Hagan – 14 points

Friday 30 April – 8 players – won by Terry Woods – 13 points

Wednesday 05 May – 15 players – won by Ken Bradley – 13 points

Friday 07 May – 6 players – won by Ken Bradley – 14 points

Wednesday 12 May - 11 players – won by Ken Bradley and John Donovan – 14 points each

Friday 14 May – 5 players – won by Mark Kont – 15 points

Wednesday 19 May - 16 players – Won by Terry Woods – 17 points

Friday 21 May - 6 players – won by John Donovan – 12 points

At the time of writing, the leading point earners in the **2021 Fred Bremner Scroungers Winter Championship** are Terry Woods (47 points) Ken Bradley (36) and Chris Pepper (35).

Scroungers golf is played at 3:30pm on Wednesdays and Fridays. We play a different six holes weekly with an emphasis on the more social aspects of the game. Any players, new or experienced, are welcome to join us.

## June Fixtures

Saturday 05 Brett Hutchinson Trophy Stableford

Saturday 12 GL Broun Trophy Stableford

Sunday 13 DRGA Event – Waroona Open Day T.B.C.

Saturday 19 Club Trophy Stableford

Sunday 20 AVGA Mixed Championships at Corrigin Stableford

Saturday 26 Wayne Smith Trophy Stroke

3<sup>rd</sup> Qualifying Round – Club Championship

## New Members...

...are always welcome. Any persons interested in playing can join us on any Saturday afternoon throughout the winter season. Tee-off is generally at 12:30pm with players asked to preferably be present by at least 12:15pm. For any further information you are invited to call Men's Captain Mark Kont on 0490 037 810.



### **Based in Balkuling...Servicing Statewide!**

For all your Lime, Gypsum, Urea, Sulphate of Ammonia,  
Chook Manure and Compound Fertiliser Spreading needs.

We also supply, deliver and spread Fertiliser from bulk bags for Hobby Farms!

**Ph. Jim - 0427 777 765**  
**ballantyne@bordnet.com.au**

## **BEVERLEY CHIROPRACTIC CENTRE** **Dr Liam Welfar**

**CORNERSTONE BUILDING**

141 Vincent St, Beverley

(Entrance off Dawson St)

**08 9646 0523**

**Back Pain? Neck Pain? Headaches?**  
**Sporting Injuries? Postural Problems?**  
**Call us today to find out how I can help.**

**Hicaps facility available onsite**



# Beverley Horse and Pony Club



*Who's been out and about ....*

**PPMG History:** PPMG stands for Prince Phillip Mounted Games. It is the inspiration of H.R.H. Prince Philip. When Col. Sir Mike Ansell was Director of the Horse of the Year Show, Prince Philip asked if he could devise a competition for children who could not afford an expensive, well-bred pony, and in 1957 the Horse of the Year Show, then at Harringay Arena, staged the first Mounted Games Championship for the Prince Philip Cup – it was an immediate success and the PPMG was born!

**PPMG Games Practice:** The Saturday before our rally we had a small, but dedicated group of riders set up and ride a range of games for PPMG. Each year the events adds a few new games to learn and others to refine. Fantastic to see Tealah, Shenae and Mia all working together to develop their skills and thank you to Marie Hammond for coaching them through each game. Below is the 'Stepping Stones' game.



**Avon Zone ODE:** On the 15th & 16th May, Tealah, riding Erigolia Tor Calon (aka Lizzie) and Jessamin, riding Playboy both attended this event at Avon Valley SJPC. Jessamin had a challenging weekend with her horse deciding that he would argue her every step of the way, but they completed each phase and finished the event. This was little Lizzie's first ODE event and Tealah was super proud that her pony completed dressage and show jumping before retiring on the cross county phase.



**May Rally:** Sunday 09 and Mother's Day! So all the mum's were up early loading riders and ponies into floats to be at our rally by 7:30am. Then we all had to set up the show jumping arena, games equipment, dressage arena and lead line arena. Then support our riders throughout the day and then pack everything away before heading home for a well deserved foot massage at about 3pm. So, Happy Mother's Day to all our amazing pony club Mum's!

## Beverley (West Aust) Horse And Pony Club Events

### 2021 Committee contacts:

**President:** Lisa Maxwell  
**Secretary:** Tess Hawke  
**Treasurer:** Di Ballantyne  
**Coach Co:** Jessamin Pain



**beverleyhorsenadponyclub**

**E** l.a.maxwell6@gmail.com      **M** 0408 902 701  
**E** keely@westnet.com.au      **M** 0419 879 310  
**E** ballantyne@bournet.com.au      **M** 042 7777 764  
**E** bevpc.coaching@gmail.com      **M** 044 7722 958

### 2021 Upcoming dates and events ...

#### June 6 & 7

12 & 13 June  
19 June  
20 June  
26 June  
27 June

#### July 3 & 4

4 July  
11 July  
16 & 17 July  
31 July & 1 Aug

#### **Pony Club Festival**

MGA (Mounted Games Association)  
**BHPC Gymkhana (open to all riders)**  
**BHPC 5<sup>th</sup> Rally**  
**Active Riding Training Day**  
**Avon Zone Active Riding Runoffs**

#### **Avon Zone Camp**

**Avon Zone Dressage Runoffs**  
**BHPC 6<sup>th</sup> Rally**  
Eastern Zone ODE  
**State Active Riding Qualifier**

Murray Horse & Pony Club

Beverley HPC  
Beverley HPC  
Beverley HPC  
Beverley HPC  
Beverley HPC

Avon Valley SJPC, Northam

Avon Valley SJPC, Northam  
Beverley HPC, Beverley  
Kellerberrin PC, Kellerberrin  
TBC



## EVENTS 2021

EVENT	DATE
CWA Social Morning Tea	02 June
Beverley Motorcycle Club - Ride Park Day	11 July
Commonwealth Bank in Beverley	21 & 22 July
Avon Valley Ladies Golf Championships	04 - 06 August
Miss Westralia at Platform Theatre	08 August
Truck Driving Training	09-20 August
Beverley Ag Show day	21 August
Voice Moves Choir Muster	11 September
Landslide Fleetwood Mac/Eagles Tribute Night	06 November
Community Christmas Party	18 December

The flag was flown at half-mast on the Beverley Town Hall as a mark of respect to:-

- DORMAN, STANLEY  
ALEXANDER
- FOGLIANI, IRENE

### **Emergency Medical Information Book**

This useful book contains all a person's information and medicals record needed if, or when, an ambulance is called, and they need to be transported to a hospital. The Emergency Medical Information Book Available for a \$2 donation at Beverley Farm Services.

Support your local groups

# BEVERLEY BLARNEY

**900 copies each month**

Community notices are free of charge

**The deadline for the next  
Beverley Blarney is 4pm  
Tuesday 22 June 2021**

Contact our friendly Shire staff today  
Shire of Beverley

PO Box 20 Beverley WA 6304

**Phone:** 9646 1200

**Email:** blarney@beverley.wa.gov.au

#### **DISCLAIMER**

*The information in this publication is of a general nature as a service to the ratepayer. The articles included herein are not intended to provide a complete discussion of each subject. While the information is believed to be correct, no responsibility is accepted for its accuracy. No liability is accepted for any statements of opinion or any error or omission.*

HAVE YOU BEEN GLIDING YET?  
BOOK YOUR FLIGHT TODAY, GO TO BEVERLEYWA.COM FOR MORE INFORMATION



*Do you want to advertise in the*  
*Beverley Blarney*  
**ADVERTISING RATES**

#### **Monthly Advertising**

Size G - Full Page	\$182	
Size A - 122 x 180mm	\$96	
Size F - 122 x 135mm	\$72	
Size B - 122 x 89mm	\$47	
Size C - 60 x 89mm	\$29	
Size D - 5 lines*	\$8	*MUST BE PAID IN ADVANCE
Size E - 3 lines*	\$5	*MUST BE PAID IN ADVANCE
Trading Post*	\$3	*MUST BE PAID IN ADVANCE

- 120 characters max.

#### **Annual Advertising**

Size G - Full Page	\$1,820
Size A - 122 x 180mm	\$960
Size F - 122 x 135mm	\$710
Size B - 122 x 89mm	\$470
Size C - 60 x 89mm	\$290



# JUNE 2021

MONDAY	TUESDAY	WEDNESDAY	THURSDAY	FRIDAY	SATURDAY	SUNDAY
	1 Mens Shed  Quilting  Stay Active Garden & Tree Meeting  Golf  LEGO Club	2 CWA Social Morning Tea  Badminton  RAOB  Netball Fast 5  Golf Scroungers	3 Line Dancing  Playgroup  LEGO Club	4 OP Shop  Golf Scroungers	5 OP Shop  Community Markets  Golf  Samba at CWA	6 Tractor Pull  Dead Finish Museum Open
7 PUBLIC HOLIDAY WA Day	8 Mens Shed  Quilting  Stay Active  Golf  LEGO Club  KERBSIDE COLLECTION	9 Badminton  Netball Fast 5  Golf Scroungers	10 Line Dancing  Playgroup  LEGO Club	11 OP Shop  Golf Coaching  Golf Scroungers  Recycle Bin	12 Golf  Samba at CWA  Beverley Horse & Pony Club - MGA	13 Dead Finish Museum Open  Beverley Horse & Pony Club - MGA  Clay Target Shooting Club Open  Footy in Beverley
14 RSL Meeting  Swap it up at CRC  Weight Watchers  Dance  Bridge at CWA  Shire of Beverley Annual Electors Meeting  Historical Meeting	15 Mens Shed  Quilting  Stay Active  Golf  LEGO Club	16 CWA Meeting  Badminton  Netball Fast 5  Golf Scroungers	17 Line Dancing  Playgroup  LEGO Club  Marketing your Business Online Workshop at CRC	18 OP Shop  Golf Scroungers	19 Golf  Samba at CWA  BHPC - Gymkhana Fun Day	20 Dead Finish Museum Open  BHPC - Rally
21 Swap it up at CRC  Weight Watchers  Dance  Bridge at CWA	22 Mens Shed  Quilting  Stay Active  Golf  LEGO Club  Council Meeting Blarney Deadline	23 Badminton  Netball- Fast 5  Golf Scroungers  Storytime & Toy Library	24 Line Dancing  Playgroup  LEGO Club	25 OP Shop  Golf Scroungers  Golf Coaching  Friday Bingo  Winter Warmers Stall  Recycle Bin	26 Golf  Samba at CWA  BHPC - Active Riding Training Day	27 Dead Finish Museum Open  Footy in Beverley  BHPC - Avon Zone Active Riding Runoffs
28 Swap it up at CRC  Weight Watchers  Dance  Bridge at CWA	29 Mens Shed  Quilting  Stay Active  Golf  LEGO Club	30 Badminton  Netball-Fast 5  Golf Scroungers				